



**Federal Aviation  
Administration**

**Aeronautical Information Services**  
**Aeronautical Chart**  
**Users' Guide**

**Effective as of 21 May 2020**



# Table of Contents

<b>INTRODUCTION</b> .....	<b>7</b>
KEEP YOUR CHARTS CURRENT .....	7
EFFECTIVE DATE OF CHART USERS' GUIDE AND UPDATES.....	7
COLOR VARIATION .....	7
REPORTING CHART DISCREPANCIES.....	7
<b>WHAT'S NEW?</b> .....	<b>9</b>
VFR CHARTS.....	9
IFR ENROUTE CHARTS .....	9
TERMINAL PROCEDURE PUBLICATIONS (TPPS).....	9
<b>EXPLANATION OF VFR TERMS AND SYMBOLS</b> .....	<b>11</b>
WATER FEATURES (HYDROGRAPHY) .....	11
LAND FEATURES (TERRAIN) AND OBSTRUCTIONS.....	11
LAND FEATURES - MOUNTAIN PASSES.....	14
RADIO AIDS TO NAVIGATION .....	15
AIRPORTS .....	15
AIRSPACE.....	17
TERMINAL AREA CHART (TAC) COVERAGE .....	20
INSET AND SPECIAL CHART COVERAGE.....	20
CHART TABULATIONS.....	20
CARIBBEAN VFR AERONAUTICAL CHARTS (CAC).....	22
<b>VFR SECTIONAL AND TERMINAL AREA CHARTS</b> .....	<b>23</b>
AIRPORTS .....	23
RADIO AIDS TO NAVIGATION .....	25
AIRSPACE INFORMATION.....	26
NAVIGATIONAL AND PROCEDURAL INFORMATION .....	32
CULTURE.....	34
HYDROGRAPHY .....	37
RELIEF .....	40
<b>VFR FLYWAY PLANNING CHARTS</b> .....	<b>43</b>
GENERAL INFORMATION.....	43
AIRPORTS .....	43
RADIO AIDS TO NAVIGATION .....	43
AIRSPACE INFORMATION.....	44
NAVIGATIONAL AND PROCEDURAL INFORMATION .....	47
CULTURE.....	47
BOUNDARIES.....	47
HYDROGRAPHY .....	48
RELIEF .....	48
<b>HELICOPTER ROUTE CHARTS</b> .....	<b>49</b>
GENERAL INFORMATION.....	49
AIRPORTS .....	49
RADIO AIDS TO NAVIGATION .....	50

# Table of Contents

AIRSPACE INFORMATION.....	51
NAVIGATIONAL AND PROCEDURAL INFORMATION .....	54
CULTURE.....	55

## **AIRSPACE ..... 57**

## **EXPLANATION OF IFR ENROUTE TERMS ..... 59**

AIRPORTS .....	59
RADIO AIDS TO NAVIGATION .....	61
AIRSPACE INFORMATION.....	62
INSTRUMENT AIRWAYS .....	64
TERRAIN CONTOURS ON AREA CHARTS.....	67
AIRPORTS .....	69

## **IFR ENROUTE LOW / HIGH ALTITUDE SYMBOLS (U.S., PACIFIC AND ALASKA CHARTS) ..... 69**

RADIO AIDS TO NAVIGATION .....	70
AIRSPACE INFORMATION.....	75
NAVIGATIONAL AND PROCEDURAL INFORMATION .....	88
CULTURE.....	89
HYDROGRAPHY .....	89
TOPOGRAPHY .....	89

## **U.S. TERMINAL PROCEDURES PUBLICATION ..... 91**

EXPLANATION OF TPP TERMS AND SYMBOLS .....	91
INSTRUMENT APPROACH PROCEDURE CHART.....	92
PLANVIEW .....	99
NAVAIDS .....	102
MISSED APPROACH INFORMATION.....	108
PROFILE VIEW.....	109
LANDING MINIMUMS.....	112
AIRPORT SKETCH .....	114
AIRPORT DIAGRAMS .....	115
DEPARTURE PROCEDURES (DPs).....	117
STANDARD TERMINAL ARRIVAL (STARs) CHARTS .....	118
CHARTED VISUAL FLIGHT PROCEDURE (CVFP) CHARTS .....	118

## **U.S. TERMINAL PROCEDURES PUBLICATION SYMBOLS ..... 119**

GENERAL INFORMATION.....	119
LEGEND - STANDARD TERMINAL ARRIVAL (STAR) CHARTS - DEPARTURE PROCEDURE (DP) CHARTS.....	119
APPROACH LIGHTING SYSTEM.....	120
AIRPORT DIAGRAM/AIRPORT SKETCH .....	122
PLANVIEW SYMBOLS.....	123
PROFILE VIEW.....	125
COLD TEMPERATURE AIRPORTS.....	126

# Table of Contents

<b>REFERENCES.....</b>	<b>127</b>
<b>ABBREVIATIONS .....</b>	<b>129</b>
A.....	129
B.....	129
C.....	129
D.....	129
E.....	129
F.....	129
G.....	129
H.....	130
I.....	130
J.....	130
K.....	130
L.....	130
M.....	130
N.....	130
O.....	130
P.....	130
R.....	131
S.....	131
T.....	131
U.....	131
V.....	131
W.....	131



# INTRODUCTION

This Chart Users' Guide is an introduction to the Federal Aviation Administration's (FAA) aeronautical charts and publications. It is useful to new pilots as a learning aid, and to experienced pilots as a quick reference guide.

The FAA is the source for all data and information utilized in the publishing of aeronautical charts through authorized publishers for each stage of Visual Flight Rules (VFR) and Instrument Flight Rules (IFR) air navigation including training, planning, and departures, enroute (for low and high altitudes), approaches, and taxiing charts. Digital charts are available online at:

- VFR Charts - [https://www.faa.gov/air\\_traffic/flight\\_info/aeronav/digital\\_products/vfr/](https://www.faa.gov/air_traffic/flight_info/aeronav/digital_products/vfr/)
- IFR Charts - [https://www.faa.gov/air\\_traffic/flight\\_info/aeronav/digital\\_products/ifr/](https://www.faa.gov/air_traffic/flight_info/aeronav/digital_products/ifr/)
- Terminal Procedures Publication - [http://www.faa.gov/air\\_traffic/flight\\_info/aeronav/digital\\_products/dtpp/](http://www.faa.gov/air_traffic/flight_info/aeronav/digital_products/dtpp/)
- Chart Supplements - [https://www.faa.gov/air\\_traffic/flight\\_info/aeronav/digital\\_products/dafd/](https://www.faa.gov/air_traffic/flight_info/aeronav/digital_products/dafd/)

Paper copies of the charts are available through an FAA Approved Print Provider. A complete list of current providers is available at [http://www.faa.gov/air\\_traffic/flight\\_info/aeronav/print\\_providers/](http://www.faa.gov/air_traffic/flight_info/aeronav/print_providers/)

The FAA Aeronautical Information Manual (AIM) Pilot/Controller Glossary defines in detail, all terms and abbreviations used throughout this publication. Unless otherwise indicated, miles are nautical miles (NM), altitudes indicate feet above Mean Sea Level (MSL), and times used are Coordinated Universal Time (UTC).

The Notices to Airmen Publication (NOTAM) includes current Flight Data Center (FDC) NOTAMs. NOTAMs alert pilots of new regulatory requirements and reflect changes to Standard Instrument Approach Procedures (SIAPs), flight restrictions, and aeronautical chart revisions. This publication is prepared every 28 days by the FAA, and is available by subscription from the Government Printing Office. For more information on subscribing or to access online PDF copy, [http://www.faa.gov/air\\_traffic/publications/notices/](http://www.faa.gov/air_traffic/publications/notices/)

In addition to NOTAMs, the Chart Supplement and the Safety Alerts/Charting Notices page of the Aeronautical Information Services website are also useful to pilots

## KEEP YOUR CHARTS CURRENT

Aeronautical information changes rapidly, so it is important that pilots check the effective dates on each aeronautical chart and publication. To avoid danger, it is important to always use current editions and discard obsolete charts and publications.

To confirm that a chart or publication is current, refer to the next scheduled edition date printed on the cover. Pilots should also check Aeronautical Chart Bulletins and NOTAMs for important updates between chart and publication cycles that are essential for safe flight.

## EFFECTIVE DATE OF CHART USERS' GUIDE AND UPDATES

All information in this guide is effective as of **21 May 2020**. All graphics used in this guide are for educational purposes. Chart symbology may not be to scale. Please do not use them for flight navigation.

The Chart Users' Guide is updated as necessary when there is new chart symbology or changes in the depiction of information and/or symbols on the charts. When there are changes, it will be in accordance with the 56-day aeronautical chart product schedule.

## COLOR VARIATION

Although the digital files are compiled in accordance with charting specifications, the final product may vary slightly in appearance due to differences in printing techniques/processes and/or digital display techniques.

## REPORTING CHART DISCREPANCIES

Your experience as a pilot is valuable and your feedback is important. We make every effort to display accurate information on all FAA charts and publications, so we appreciate your input. Please notify us concerning any requests for changes, or potential discrepancies you see while using our charts and related products.

*FAA, Aeronautical Information Services  
1305 East-West Highway  
SSMC4, Room 3424  
Silver Spring, MD 20910-3281*

*Telephone Toll-Free 1-800-638-8972  
Aeronautical Inquires: [https://www.faa.gov/air\\_traffic/flight\\_info/aeronav/aero\\_data/Aeronautical\\_Inquiries/](https://www.faa.gov/air_traffic/flight_info/aeronav/aero_data/Aeronautical_Inquiries/)*





# WHAT'S NEW?

Update as of 21 May 2020

The following charting items have been added to the Online Chart Users' Guide since the Guide was last published on 26 March 2020:

## VFR CHARTS

### Revision of Trauma Center and Hospital Helipad Designations on Helicopter Route Charts

Beginning with the 18 June 2020 effective date, users' will begin to see Trauma Center and Hospital Helipad designations charted under the broader heading of Medical Center.

---

## IFR ENROUTE CHARTS

### Coincident Airways/Routes with Unusable Segment

No Changes Applied

---

## TERMINAL PROCEDURE PUBLICATIONS (TPPS)

No Changes Applied



# EXPLANATION OF VFR TERMS AND SYMBOLS

This chapter covers the Sectional Aeronautical Chart (Sectional). These charts include the most current data at a scale of (1:500,000) which is large enough to be read easily by pilots flying by sight under Visual Flight Rules. Sectionals are named after a major city within its area of coverage.

The chart legend includes aeronautical symbols and information about drainage, terrain, the contour of the land, and elevation. You can learn to identify aeronautical, topographical, and obstruction symbols (such as radio and television towers) by using the legend.

A brief description next to a small black square indicates the exact location for many of the landmarks easily recognized from the air, such as stadiums, pumping stations, refineries, etc. A small black open circle with descriptive type indicates oil, gas or mineral wells. A small black circle with descriptive type indicates water, oil or gas tanks. The scale for some items may be increased to make them easier to read on the chart.

Aeronautical Information Services' charts are prepared in accordance with specifications of the Interagency Air Committee (IAC) and are approved by representatives of the Federal Aviation Administration (FAA) and the Department of Defense (DoD).

## WATER FEATURES (HYDROGRAPHY)

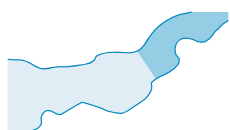

Water features are depicted using two tones of blue, and are considered either "Open Water" or "Inland Water." "Open Water," a lighter blue tone, shows the shoreline limitations of all coastal water features at the average (mean) high water levels for oceans and seas. Light blue also represents the connecting waters like bays, gulfs, sounds and large estuaries.

Exceptionally large lakes like the Great Lakes, Great Salt Lake, and Lake Okeechobee, etc., are considered Open Water features. The Open Water tone extends inland as far as necessary to adjoin the darker blue "Inland Water" tones. All other bodies of water are marked as "Inland Water" in the darker blue tone.

## LAND FEATURES (TERRAIN) AND OBSTRUCTIONS

The elevation and configuration of the Earth's surface is important to pilots. Our Aeronautical Information Specialists are devoted to showing the contour of the earth and any obstructions clearly and accurately on our charts. We use five different techniques: contour lines, shaded relief, color tints, obstruction symbols, and Maximum Elevation Figures (MEF).

1. Contour lines join points of equal elevation. On Sectionals, basic contours are spaced at 500' intervals. Intermediate contours are typically at 250' intervals in moderately level or gently rolling areas. Auxiliary contours at 50', 100', 125', or 150' intervals occasionally show smaller relief features in areas of relatively low relief. The pattern of these lines and their spacing gives the pilot a visual concept of the terrain. Widely spaced contours represent gentle slopes, while closely spaced contours represent steep slopes.
2. Shaded relief shows how terrain may appear from the air. Shadows are shown as if light is coming from the northwest, because studies have shown that our visual perception has been conditioned to this view.
3. Different color tints show bands of elevation relative to sea level. These colors range from light green for the lower elevations, to dark brown for the higher elevations.



- Obstruction symbols show man made vertical features that could affect safe navigation. FAA's Aeronautical Information Manual (AIM) maintains a database of over obstacles in the United States, Canada, the Caribbean, Mexico and U.S. Pacific Island Territories. Aeronautical Specialists evaluate each obstacle based on charting specifications before adding it to a visual chart. When a Specialist is not able to verify the position or elevation of an obstacle, it is marked UC, meaning it is "under construction" or being reported, but has not been verified.

The FAA uses a Digital Obstacle File (DOF) to collect and disseminate data. Because land and obstructions frequently change, the source data on obstructions and terrain is occasionally incomplete or not accurate enough for use in aeronautical publications. For example, when the FAA receives notification about an obstruction, and there is insufficient detail to determine its position and elevation, the FAA Flight Edit Program conducts an investigation.

The Flight Edit crew visually verifies the cultural, topographic, and obstacle data. Charts are generally flight-checked every four years. This review includes checking for any obstruction that has been recently built, altered, or dismantled without proper notification.

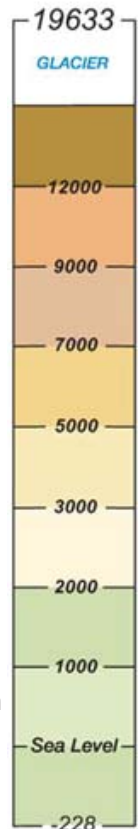

Obstacles less than 1000' AGL.



Sectional Charts, Terminal Area (TACs) and Caribbean Charts (CACs) typically show man-made obstacles extending more than 200' Above Ground Level (AGL), or more than 299' AGL in yellow city tint. Features considered to be hazardous obstacles to low-level flight are; smokestacks, tanks, factories, lookout towers, and antennas, etc.

Obstacles 1000' AGL or greater.

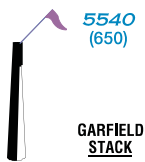

Man-made features used by FAA Air Traffic Control as checkpoints use a graphic symbol shown in black with the required elevation data in blue. The elevation of the top of the obstacle above Mean Sea Level (MSL) and the height of the structure (AGL) is also indicated (when known or can be reliably determined by a Specialist). The AGL height is in parentheses below the MSL elevation. In extremely congested areas, the FAA typically omits the AGL values to avoid confusion.



4977 (1432)

Group Obstacle Symbol

Whenever possible, the FAA depicts specific obstacles on charts. However, in high-density areas like city complexes, only the highest obstacle is represented on the chart using the group obstacle symbol to maximize legibility.

Obstacles under construction are indicated by placing the letters UC adjacent to the obstacle type.

5000 (1500) UC

If space is available, the AGL height of the obstruction is shown



Guy wires may extend outward from obstacles.

Obstacles with high-intensity strobe lighting systems may operate part-time or by proximity activation and are shown as follows:

- The Maximum Elevation Figure (MEF) represents the highest elevation within a quadrant, including terrain and other vertical obstacles (towers, trees, etc.). A quadrant on Sectionals is the area bounded by ticked lines dividing each 30 minutes of latitude and each 30 minutes of longitude. MEF figures are rounded up to the nearest 100' value and the last two digits of the number are not shown.

125

In this example the MEF represents 12,500'.

MEFs over land and open water areas are used in areas containing man-made obstacles such as oil rigs.

In the determination of MEFs, the FAA uses extreme care to calculate the values based on the existing elevation data shown on source material. Aeronautical Information Specialists use the following procedure to calculate MEFs:

### MEF - Man-made Obstacle

When a man-made obstacle is more than 200' above the highest terrain within the quadrant:

1. Determine the elevation of the top of the obstacle above MSL.
2. Add the possible vertical error of the source material to the above figure (100' or 1/2 contour interval when interval on source exceeds 200'. U.S. Geological Survey Quadrangle Maps with contour intervals as small as 10' are normally used).
3. Round the resultant figure up to the next higher hundred-foot level.

#### Example:

Elevation of obstacle top (MSL)	2649
Possible obstacle error	+100
equals	2749
Raise to the following 100' level	2800
Maximum Elevation Figure (MEF)	28

28

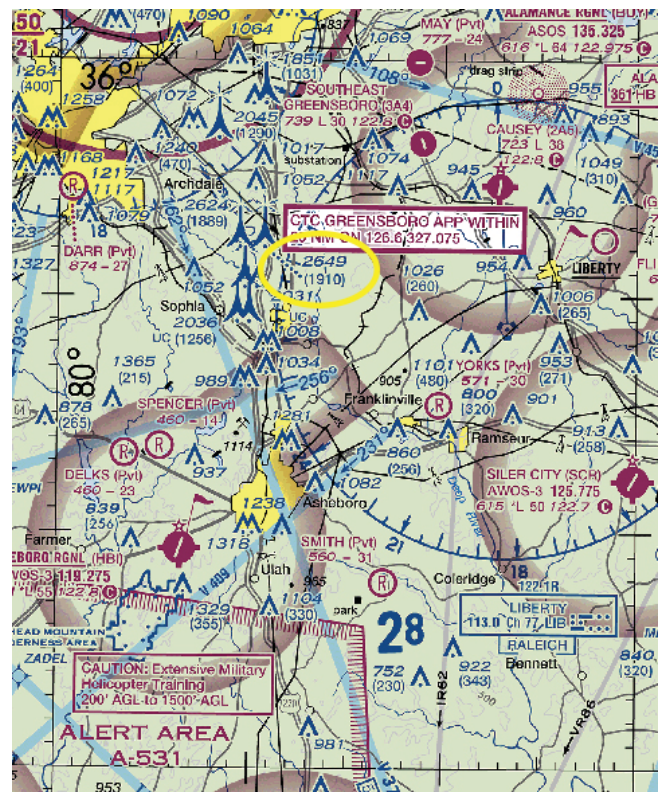

## MEF - Natural Terrain Feature or Natural Vertical Obstacle

When a natural terrain feature or natural vertical obstacle (e.g. a tree) is the highest feature within the quadrangle:

1. Determine the elevation of the feature.
2. Add the possible vertical error of the source to the above figure (100' or 1/2 the contour interval when interval on source exceeds 200').
3. Add a 200' allowance for uncharted natural or manmade obstacles. Chart specifications don't require the portrayal of obstacles below minimum height.
4. Round the figure up to the next higher hundred-foot level.

**Example:**

**Elevation of obstacle top (MSL) 13161**

**Possible vertical error +100**

**Obstacle Allowance +200**

**equals 13461**

**Raise to the following 100' level 13500**

**Maximum Elevation Figure (MEF) 135**

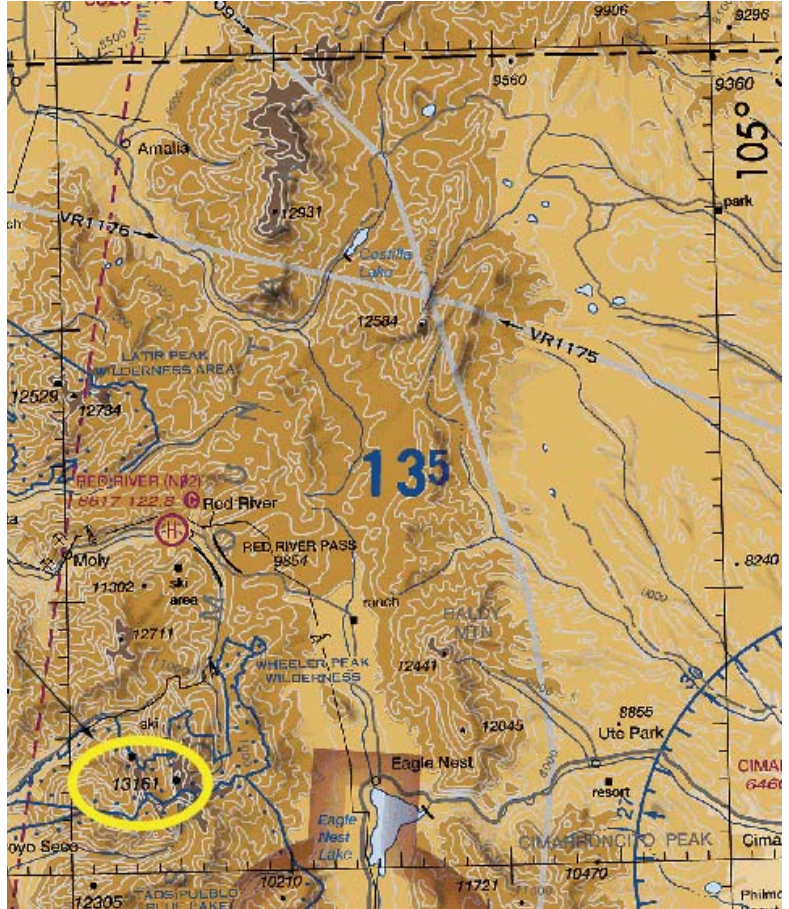

Pilots should be aware that while the MEF is based on the best information available to the Specialist, the figures are not verified by field surveys. Also, users should consult the Aeronautical Chart Bulletin in the Chart Supplement or Aeronautical Information Services website to ensure that your chart has the latest MEF data available.

## LAND FEATURES - MOUNTAIN PASSES

Mountain Pass symbol does not indicate a recommended route or direction of flight and pass elevation does not indicate a recommended clearance altitude. Hazardous flight conditions may exist within and near mountain passes.

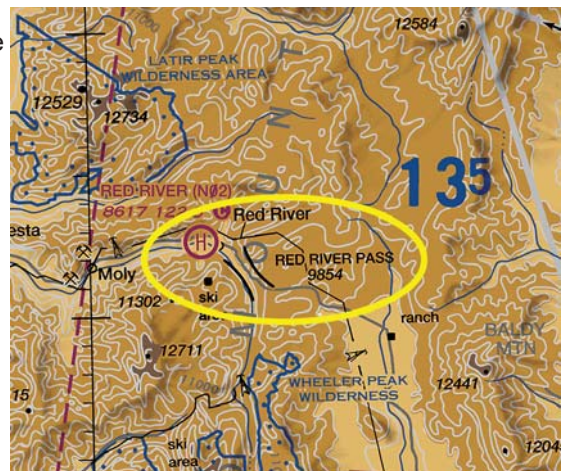

# RADIO AIDS TO NAVIGATION

On VFR Charts, information about radio aids to navigation (NAVAID) are boxed, as illustrated. Duplication of data is avoided. When two or more radio aids in a general area have the same name with different frequencies, Tactical Air Navigation (TACAN) channel numbers, or identification letters, and no misinterpretation can result, the name of the radio aid may be indicated only once within the identification box. Very High Frequency/Ultra High Frequency (VHF/UHF) NAVAID names and identification boxes (shown in blue) take precedence. Only those items that differ (e.g., frequency, Morse Code) are repeated in the box in the appropriate color. The choice of separate or combined boxes is made in each case on the basis of economy of space and clear identification of the radio aids.

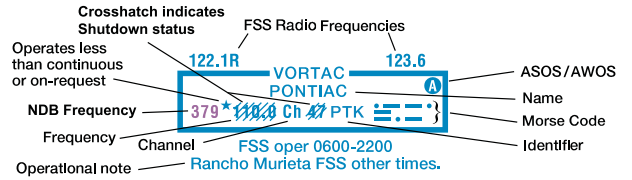

A NAVAID that is physically located on an airport may not always be represented as a typical NAVAID symbol. A small open circle indicates the NAVAID location when collocated with an airport icon.

The type of NAVAID will be identified by: "VOR," (VHF Omni-Directional Range) "VORTAC" (VOR Tactical Aircraft Control), "VOR-DME," (VOR-Distance Measuring Equipment) or "DME" (Distance Measuring Equipment) positioned on and breaking the top line of the NAVAID box.

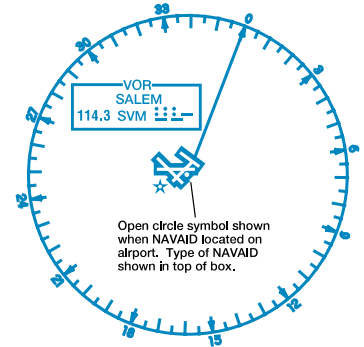

DMEs are shown without the compass rose.

## AIRPORTS

Airports in the following categories are charted as indicated (additional symbols are shown later in this Section).  
Public use airports:

- Hard-surfaced runways greater than 8069' or some multiple runways less than 8069'
- Hard-surfaced runways 1500' to 8069'
- Other than hard-surfaced runways
- Seaplane bases

Military airports:

- Other than hard-surfaced runways

Hard-surfaced runways are depicted the same as public-use airports.

U.S. military airports are identified by abbreviations such as AAF (Army Air Field), AFB (Air Force Base), MCAS (Marine Corps Air Station), NAS (Naval Air Station), NAV (Naval Air Facility), NAAS (Naval Auxiliary Air Station), etc. Canadian military airports are identified by the abbreviation DND (Department of National Defense).

Fuel Available:

- Fuel availability indicated by use of tick marks around the basic airport symbol. Consult Chart Supplement for details and availability.

Other airports with or without fuel:

- H
- F
- U
- R
- X

Airports are plotted in their true geographic position unless the symbol conflicts with a NAVAID at the same location. In such cases, the airport symbol will be displaced, but the relationship between the airport and the NAVAID will be retained.

Airports are identified by their designated name. Generic parts of long airport names (such as "airport," "field," or "municipal") and the first names of persons are commonly omitted unless they are needed to distinguish one airport from another with a similar name.

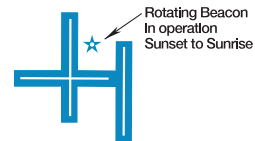

The figure at right illustrates the coded data that is provided along with the airport name.

FSS  
NO SVFR  
NAME (NAM) (PNAM)  
CT - 118.3 \* ATIS 123.8  
285 L 72 122.95 ← UNICOM  
RP 23, 34  
VFR Advsy 125.0  
AOE

The elevation of an airport is the highest point on the usable portion of the landing areas. Runway length is the length of the longest active runway, including displaced thresholds and excluding overruns. Runway length is shown to the nearest 100', using 70 as the rounding point; a runway 8070' in length is charted as 81, while a runway 8069' in length is charted as 80. If a seaplane base is collocated with an airport, there will be additional seaplane base water information listed for the elevation, lighting and runway.

FAA Chart Users' Guide - VFR Terms and Symbols

<i>Flight Service Station on field</i>	FSS	<i>Elevation in feet</i>	285
<i>Airports where fixed wing special VFR operations are prohibited (shown above airport name) FAR 91</i>	NO SVFR	<i>Lighting in operation Sunset to Sunrise</i>	L
<i>Indicates FAR 93 Special Air Traffic Rules and Airport Traffic Pattern</i>		<i>Lighting limitations exist; refer to Chart Supplement</i>	*L
<i>Location Identifier</i>	(NAM)	<i>Length of longest runway in hundreds of feet; usable length may be less.</i>	72
<i>ICAO Location Identifier</i>	(PNAM)	<i>Aeronautical advisory station</i>	122.95
<i>Control Tower (CT) - primary frequency</i>	CT - 118.3	<i>Runways with Right Traffic Patterns (public use)</i>	RP 23,34
<i>Star indicates operation part-time. See tower frequencies tabulation for hours of operation</i>	*	<i>See Chart Supplement</i>	*RP
<i>Follows the Common Traffic Advisory Frequency (CTAF)</i>		<i>VFR Advisory Service Shown when ATIS is not available and frequency is other than the primary CT frequency.</i>	VFR Advsy 125.0
<i>Automatic Terminal Information Services</i>	ATIS 123.8	<i>Weather Camera (Alaska)</i>	WX CAM
<i>Automatic Flight Information Service</i>	AFIS 135.2	<i>Airport of Entry</i>	AOE
<i>Automated Surface Weather Observing Systems; shown when full-time ATIS is not available.</i>	ASOS/AWOS 135.42	<i>When information is lacking, the respective character is replaced by a dash. Lighting codes refer to runway edge lights and may not represent the longest runway or full length lighting.</i>	

Airports with Control Towers (CT) and their related data are shown in blue. All other airports and their related data are shown in magenta. The L symbol indicates that runway lights are on from dusk to dawn. \*L indicates that the pilot must consult the Chart Supplement to determine runway lighting limitations, such as: available on request (by radio-call, letter, phone, etc), part-time lighting, or pilot/airport controlled lighting. Lighting codes refer to runway edge lights. The lighted runway may not be the longest runway available, and lights may not be illuminated along the full length of the runway. The Chart Supplement has a detailed description of airport and air navigation lighting aids for each airport. A dash represents no runway edge lights.

The symbol indicates the existence of a rotating or flashing airport beacon operating from dusk to dawn. The Aeronautical Information Manual (AIM) thoroughly explains the types and uses of airport lighting aids.

Right traffic information is shown using the abbreviation 'RP' for right pattern, followed by the appropriate runway number(s) (RP 18). Special conditions or restrictions to the right pattern are indicated by the use of an asterisk (\*RP) to



direct the pilot to the Chart Supplement for special instructions and/or restrictions.

The type "OBJECTIONABLE" associated with an airport symbol indicates that an objectionable airspace determination has been made for the airport per FAA JO 7400.2 Section 4, Airport Charting and Publication of Airport Data. Objectionable airspace determinations are based upon a number of factors including conflicting traffic patterns with another airport, hazardous runway conditions, or natural or man-made obstacles in close proximity to the landing area. FAA Regional Airports Offices are responsible for airspace determinations. Address any challenges to objectionable airspace determinations to your FAA Regional Airports Office.

## AIRSPACE

### CONTROLLED AIRSPACE

Controlled airspace consists of those areas where some or all aircraft may be subject to air traffic control, such as: Class A, Class B, Class C, Class D, Class E Surface (SFC) and Class E Airspace.

**Class A Airspace** within the United States extends from 18,000' up to FL600. While visual charts do not depict Class A, it is important to note its existence.

**Class B Airspace** is shown in abbreviated form on the Caribbean Charts (CAC) . The Sectional Aeronautical Chart (Sectional) and Terminal Area Chart (TAC) show Class B in greater detail. The MSL ceiling and floor altitudes of each sector are shown in solid blue figures with the last two zeros omitted. Floors extending "upward from above" a certain altitude are preceded by a (+). Operations at and below these altitudes are outside of Class B Airspace. Radials and arcs used to define Class B are prominently shown on TACs. Detailed rules and requirements associated with the particular Class B are shown. The name by which the Class B is shown as **LAS VEGAS CLASS B** for example.

*Class B MSL* **90**  
*Altitudes* **20**

**Class C Airspace** is shown in abbreviated form on Caribbean Charts (CAC). Sectionals and TACs show Class C in greater detail. The MSL ceiling and floor altitudes of each sector are shown in solid magenta figures with the last two zeros eliminated.

*Class C MSL* **70**  
*Altitudes* **15**

**T**  
**SFC** The figure at left identifies a sector that extends from the surface to the base of the Class B.

Class C Airspace is identified by name: **BURBANK CLASS C**

Separate notes, enclosed in magenta boxes, give the approach control frequencies to be used by arriving VFR aircraft to establish two-way radio communication before entering the Class C (generally within 20 NM):

CTC BURBANK APP WITHIN  
20 NM ON 124,6 395,9

Class C operating less than continuous is indicated by the following note: See NOTAMs/Supplement for Class C eff hrs

**Class D Airspace** is identified with a blue dashed line. Class D operating less than continuous is indicated by the following note: See NOTAMs/Supplement for Class D eff hrs

Ceilings of Class D are shown as follows: **[30]**

A minus in front of the figure is used to indicate "from surface to, but not including..."

**Class E Surface (SFC) Airspace** is symbolized with a magenta dashed line. Class E (SFC) operating less than continuous is indicated by the following note: See NOTAMs/Supplement for Class E (sfc) eff hrs

**Class E Airspace** exists at 1200' AGL unless designated otherwise. The lateral and vertical limits of all Class E, (up to, but not including 18,000') are shown by narrow bands of vignette on Sectionals and TACs.

**CLASS G** Class E Airspace with floor 700 ft. above surface that laterally abuts Class G Airspace.  
Class E Airspace with floor 700 ft. above surface that laterally abuts 1200 ft. or higher Class E Airspace  
Class E Airspace with floor 1200 ft. or greater above surface that laterally abuts Class G Airspace

Controlled airspace floors of 700' above the ground are defined by a magenta vignette; floors other than 700' that laterally abut uncontrolled airspace (Class G) are defined by a blue vignette; differing floors greater than 700' above the ground are annotated by a symbol and a number indicating the floor.

**2400 AGL**  
**4500 MSL**

If the ceiling is less than 18,000' MSL, the value (preceded by the word "ceiling") is shown along the limits of the controlled airspace. These limits are shown with the same symbol indicated above.

## UNCONTROLLED AIRSPACE

**Class G Airspace** within the United States extends up to 14,500' Mean Sea Level. At and above this altitude is Class E, excluding the airspace less than 1500' above the terrain and certain special use airspace areas.

## SPECIAL USE AIRSPACE

**Special Use Airspace (SUA)** confines certain flight activities and restricts entry, or cautions other aircraft operating within specific boundaries. Except for Controlled Firing Areas, SUA areas are depicted on VFR Charts. Controlled Firing Areas are not charted because their activities are suspended immediately when spotter aircraft, radar, or ground lookout positions indicate an aircraft might be approaching the area. Nonparticipating aircraft are not required to change their flight paths. SUA areas are shown in their entirety (within the limits of the chart), even when they overlap, adjoin, or when an area is designated within another area. The areas are identified by type and identifying name/number, and are positioned either within or immediately adjacent to the area.

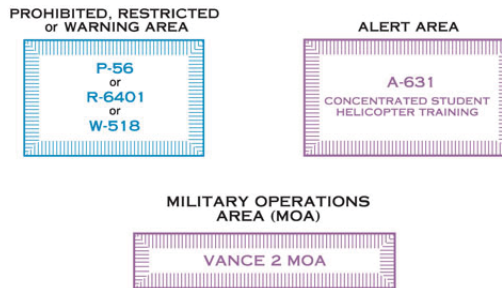

\* Alert Areas do not extend into Class A, B, C and D airspace, or Class E airport surface areas.

## OTHER AIRSPACE AREAS

**Mode C Required Airspace** (from the surface to 10,000' MSL) within a 30 NM radius of the primary airport(s) for which a Class B is designated, is depicted by a solid magenta line.



Mode C is required, but not depicted for operations within and above all Class C up to 10,000' MSL.



Enroute Mode C requirements (at and above 10,000' MSL except in airspace at and below 2500' AGL) are not depicted. See FAR 91.215 and the AIM.

**FAR 93** Airports and heliports under Federal Aviation Regulation 93 (FAR 93), (Special Air Traffic Rules and Airport Traffic Patterns), are shown by "boxing" the airport name.





TRUCKEE - TAHOE

**FAR 91** Airports where fixed wing special visual flight rules operations are prohibited (FAR 91) are shown with the type "NO SVFR" above the airport name.

**National Security Areas** indicated with a broken magenta line  and Special Flight Rules Areas (SFRAs) indicated with the following symbol: , consist of airspace with defined vertical and lateral dimensions established at locations where there is a requirement for increased security and safety of ground facilities. Pilots should avoid flying through these depicted areas. When necessary, flight may be temporarily prohibited.

**The Washington DC Flight Restricted Zone (FRZ)** is related to National Security. It is depicted using the Prohibited/Restricted/Warning Area symbology  and is located within the SFRA. It is defined as the airspace within approximately a 13 to 15 NM radius of the DCA VOR-DME. Additional requirements are levied upon aviators requesting access to operate inside the National Capital Region.

**Temporary Flight Restriction (TFR) Areas Relating to National Security** are indicated with a broken blue line . A Temporary Flight Restriction (TFR) is a type of Notice to Airmen (NOTAM). A TFR defines an area where air travel is restricted due to a hazardous condition, a special event, or a general warning for the entire airspace. The text of the actual TFR contains the fine points of the restriction. It is important to note that only TFRs relating to National Security are charted.

**Air Defense Identification Zones (ADIZs)** are symbolized using the ADIZ symbol: . As defined in Code of Federal Regulations 14 (CFR 14) Part 99, an ADIZ is an area in which the ready identification, location, and control of all aircraft is required in the interest of national security. ADIZ boundaries include Alaska, Hawaii, Guam, Canada and the Contiguous U.S.

**Terminal Radar Service Areas (TRSAs)** are shown in their entirety, symbolized by a screened black outline of the entire area including the various sectors within the area .

The outer limit of the entire Terminal Radar Service Areas (TRSA) is a continuous screened black line. The various sectors within the TRSA are symbolized by narrower screened black lines.

Each sector altitude is identified in solid black color by the MSL ceiling and floor values of the respective sector, eliminating the last two zeros. A leader line is used when the altitude values must be positioned outside the respective sectors because of charting space limitations. The TRSA name is shown near the north position of the TRSA as follows:

**PALM SPRINGS TRSA.** Associated frequencies are listed in a table on the chart border.

**Military Training Routes (MTRs)** are shown on Sectionals and TACs. They are identified by the route designator: . Route designators are shown in solid black on the route centerline, positioned along the route for continuity. The designator IR or VR is not repeated when two or more routes are established over the same airspace, e.g., IR201-205-227. Routes numbered 001 to 099 are shown as IR1 or VR99, eliminating the initial zeros. Direction of flight along the route is indicated by small arrowheads adjacent to and in conjunction with each route designator.

The following note appears on Helicopters, Sectionals and TACs except for Hawaiian Islands which is different.

MILITARY TRAINING ROUTES (MTRs)

All IR and VR MTRs are shown, and may extend from the surface upwards. Only the route centerline, direction of flight along the route, and the route designator are depicted - route widths and altitudes are not shown.

Since these routes are subject to change every 56 days, you are cautioned and advised to contact Flight Service for route dimensions and current status for those routes affecting your flight.

Routes with a change in the alignment of the charted route centerline will be indicated in the Aeronautical Chart Bulletin of the Chart Supplement.

DoD users refer to Area Planning AP/1B Military Training Routes North and South America for current routes.

There are IFR (IR) and VFR (VR) routes as follows:

**Route identification:**

- a. Routes at or below 1500' AGL (with no segment above 1500') are identified by four-digit numbers; e.g., VR1007, etc. These routes are generally developed for flight under Visual Flight Rules.
- b. Routes above 1500' AGL (some segments of these routes may be below 1500') are identified by three or fewer digit numbers; e.g., IR21, VR302, etc. These routes are developed for flight under Instrument Flight Rules.

MTRs can vary in width from 4 to 16 miles. Detailed route width information is available in the Flight Information Publication (FLIP) AP/1B (a Department of Defense publication), or through the 56 Day NASR Subscription from the National Flight Data Center (NFDC).

**Special Military Activity** areas are indicated on Sectionals by a boxed note in black type. The note contains radio frequency information for obtaining area activity status.

SPECIAL MILITARY ACTIVITY  
CTC MOBILE RADIO  
ON 123.6  
FOR ACTIVITY STATUS

## TERMINAL AREA CHART (TAC) COVERAGE

TAC coverage is shown on appropriate Sectionals by a 1/4" masked line as indicated below. Within this area pilots should use TACs, which provide greater detail. A note indicating that the area is on the TAC appears near the masked boundary line.

### LOS ANGELES TERMINAL AREA

Pilots are encouraged to use the Los Angeles VFR Terminal Area Chart for flights at or below 10,000'

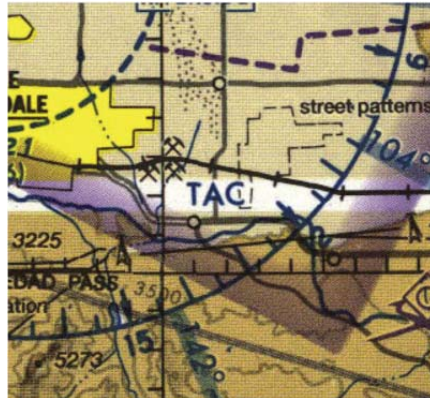

## INSET AND SPECIAL CHART COVERAGE

Inset and Special Chart Coverage (.i.e., Grand Canyon Chart) is shown on appropriate Sectionals by a 1/8" masked line as indicated below. A note to this effect appears near the masked boundary line. (Additional examples shown in VFR Sectional and Terminal Charts > Navigational and Procedural Information > Chart Limits.)

If inset chart is on the same chart as outline:

INDIANAPOLIS INSET  
See inset chart for additional detail

If inset chart is on a different chart:

INDIANAPOLIS INSET  
See inset chart on the St. Louis Sectional for additional information



## CHART TABULATIONS

**Airport Tower Communications** are provided in a columnized tabulation for all tower-controlled airports that appear on the respective chart. Airport names are listed alphabetically. If the airport is military, the type of airfield, e.g., AAF, AFB, NAS, is shown after the airfield name. In addition to the airport name, tower operating hours, primary Very High Frequency/Ultra High Frequency (VHF/UHF) local Control Tower (CT), Ground Control (GND CON), and Automatic Terminal Information Service (ATIS) frequencies, when available, will be given. Airport Surveillance Radar (ASR) and/or Precision Approach Radar (PAR) procedures are listed when available.

**Approach Control Communications** are provided in a columnized tabulation listing Class B, Class C, Terminal Radar Service Areas (TRSA) and Selected Approach Control Facilities when available. Primary VHF/UHF frequencies are provided for each facility. Sectorization occurs when more than one frequency exists and/or is approach direction dependent. Availability of service hours is also provided.

**Special Use Airspace (SUA):** Prohibited, Restricted and Warning Areas are presented in blue and listed numerically for U.S. and other countries. Restricted, Danger and Advisory Areas outside the U.S. are tabulated separately in blue. A tabulation of Alert Areas (listed numerically) and Military Operations Areas (MOA) (listed alphabetically) appear on the chart in magenta. All are supplemented with altitude, time of use and the controlling agency/contact facility, and its frequency when available. Users need to be aware that a NOTAM addressing activation will NOT be issued to announce permanently listed times of use. The controlling agency will be shown when the contact facility and frequency data is unavailable.

Airports with control towers are indicated on the face of the chart by the letters CT followed by the primary VHF tower frequency(ies). Information for each tower is listed in the table below. Operational hours are local time. The primary VHF and UHF tower and ground control frequencies are listed.

Automatic Terminal Information Service (ATIS) frequencies shown on the face of the chart are arrival VHF/UHF frequencies. All ATIS frequencies are listed in the table below. ATIS operational hours may differ from tower operational hours.

ASR and/or PAR indicate Radar Instrument Approach available.

"MON-FRI" indicates Monday through Friday.

O/T indicates other times.

**Frequencies (VHF/UHF)**

Airport Name	CONTROL TOWER	OPERATES	TOWER	GND CON	ATIS	ASR/PAR
Airports	AIRBORNE	0700 MON-1800 SAT 0600-1800 SUN	119.475	121.6	124.925	
	BLUE GRASS	CONTINUOUS	119.1 257.8	121.9	126.3	
	BOLTON	0730-1930	128.1	121.3 (E) 121.8 (W)		ASR/PAR
	CHARLOTTESVILLE-ALBEMARLE	0600-2300	124.5 338.275	121.9 338.275	118.425	PAR
	CINCINNATI/NORTHERN KENTUCKY INTL	CONTINUOUS Runway dependent	118.3 (RWYS 18R/36L & 09/27) 118.975 360.85 (RWY 18L/36R)	121.3 (E) 121.7 (W)	134.375 (ARR) 135.3 (DEP)	ASR
	COX DAYTON INTL	CONTINUOUS	119.9 257.8	121.9	125.8	
	EASTERN WV RGNL/SHEPHERD	0700-2200 TUE-THU 0700-1600 FRI-SAT 1300-1800 SUN O/T BY NOTAM	124.3 236.6	121.8 275.8		
		Hours of Operation (local time)			Approach direction dependent	
						Radar Instrument Approach available

**Frequencies (VHF/UHF)**

**CLASS B, CLASS C, TRSA AND SELECTED RADAR APPROACH CONTROL FREQUENCIES**

Airspace Name	FACILITY	FREQUENCIES	SERVICE AVAILABILITY
Airspace	CINCINNATI CLASS B	VHF { 119.7 (RWY 09/27 090 -269 ) 123.875 (RWY 09/27 270 -089 ) 363.15 UHF { 118.3 (RWY 18R/36L 180 -359 ) 118.975 360.85 (RWY 18L/36R 360 -179 )	CONTINUOUS
	CHARLESTON CLASS C	124.1 269.125 (N) 119.2 269.125 (S)	CONTINUOUS
	COLUMBUS CLASS C	120.2 317.775 (280 -099 ) 132.3 279.6 (100 -279 )	CONTINUOUS
	DAYTON CLASS C	127.65 294.5 (360 -090 ) 118.85 327.1 (091 -180 ) 134.45 316.7 (181 -359 )	CONTINUOUS
	BRISTOL TRSA	134.425 349.0 (047 -227 ) 125.5 317.5 (228 -046 ) O/T 127.85 371.85 ZTL CNTR	CONTINUOUS 0600-2400 local time
Radar Approach Control	HUNTINGTON TRSA	119.75 257.8 (S) 132.95 257.8 (N)	CONTINUOUS
	PERKINSON/BAAF RADAR	118.75 353.9	CONTINUOUS

O/T indicates Other times

**SPECIAL USE AIRSPACE ON SECTIONAL CHART**

Unless otherwise noted altitudes are MSL and in feet. Time is local.  
"TO" an altitude means "TO and including."  
FL - Flight Level  
NO A/G - No air to ground communications.  
Contact nearest FSS for information.

† Other times by NOTAM.  
NOTAM - Use of this term in Restricted Areas indicates FAA and DoD NOTAM systems. Use of this term in all other Special Use areas indicates the DoD NOTAM system.

**U.S. P-PROHIBITED, R-RESTRICTED, W-WARNING, A-ALERT, MOA-MILITARY OPERATIONS AREA**

NUMBER	ALTITUDE	TIME OF USE	CONTROLLING AGENCY/ CONTACT FACILITY	FREQUENCIES — VHF/UHF
R-6602 A	TO BUT NOT INCL 4000	CONTINUOUS MAY 1-SEP 15 124 HRS IN ADVANCE	WASHINGTON CNTR	118.75 377.1
R-6602 B	4000 TO BUT NOT INCL 11,000	BY NOTAM 24 HRS IN ADVANCE	WASHINGTON CNTR	118.75 377.1
R-6602 C	11,000 TO BUT NOT INCL 18,000	BY NOTAM 24 HRS IN ADVANCE	WASHINGTON CNTR	118.75 377.1

A-220	TO 4000 AGL	0800-2200	NO A/G
-------	-------------	-----------	--------

Alert Areas do not extend into Class A, B, C and D airspace, or Class E airport surface areas.

MOA NAME	ALTITUDE*	TIME OF USE†	CONTROLLING AGENCY/ CONTACT FACILITY	FREQUENCIES — VHF/UHF
BRUSH CREEK	100 AGL TO BUT NOT INCL 5000	0800-2200 MON-SAT	INDIANAPOLIS CNTR	134.0 135.57
BUCKEYE	5000	0800-2200 MON-FRI 0800-1600 SAT-SUN	INDIANAPOLIS CNTR	134.0 135.57
EVERS	1000 AGL	SR-SS BY NOTAM	WASHINGTON CNTR	

\*Altitudes indicate floor of MOA. All MOAs extend to but do not include FL 180 unless otherwise indicated in tabulation or on chart.  
†Other times by DoD NOTAM.

Sunrise to Sunset

**CANADA R-RESTRICTED, D-DANGER AND A-ADVISORY AREA**

Restricted Danger Advisory	NUMBER	LOCATION	ALTITUDE	TIME OF USE	CONTROLLING AGENCY
	CYR754	CONFEDERATION BRIDGE, PE	TO 500	CONTINUOUS	
	CYD734	HALIFAX, NS	TO FL 200	OCCASIONAL BY NOTAM	MONCTON ACC
	CYA702 (P)	GREENWOOD, NS	TO 500	CONT DAYLIGHT	
	CYA752 (M)	LIVERPOOL, NS	TO FL 280	CONT DAYLIGHT MON-FRI EXC HOLT†	MONCTON ACC

# CARIBBEAN VFR AERONAUTICAL CHARTS (CAC)

Starting in 2016, the FAA CARIBBEAN VFR Aeronautical Charts were first published, replacing the discontinued World Aeronautical Charts (WACs), parts of CH-25, CJ-26, and CJ-27, with CJ-26's last effective date of 1 February 2018 and CJ-27 last effective date of 29 March 2018. The Caribbean Charts are published as two VFR Charts: Caribbean 1 (CAC-1) covers Southern Florida, Cuba, Haiti and the Bahamas; Caribbean 2 (CAC-2) covers Puerto Rico, Haiti, Dominican Republic, the Lesser Antilles and Leeward Islands. CAC-1 is updated annually and CAC-2 biennially.

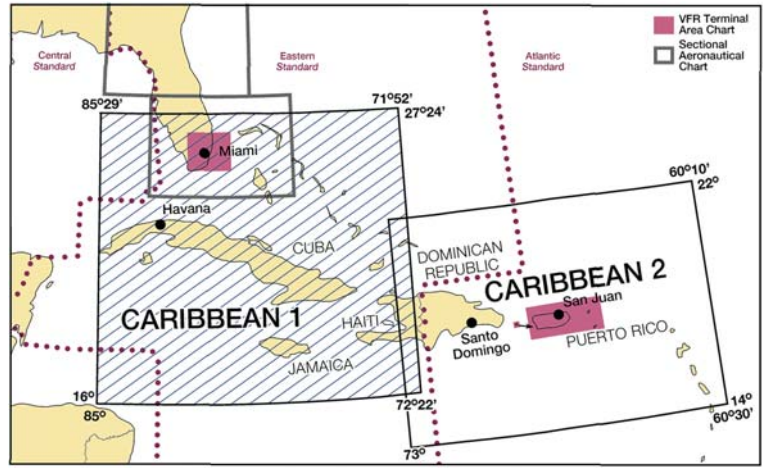

Caribbean Charts are designed for VFR and provide aeronautical and topographic information of the Caribbean. The aeronautical information includes airports, radio aids to navigation, Class B airspace and special use airspace. The topographic information includes city tint, populated places, principal roads, drainage patterns and shaded relief.

The chart symbols used on the Caribbean Charts are similar to those used in the Sectional and Terminal Area Charts, the major difference being in scale. The Caribbean VFR Chart scale is 1:1,000,000 vs the Sectional Chart Scale of 1:500,000 and Terminal Area Chart Scale of 1:250,000. Chart symbology will appear smaller on the Caribbean VFR Charts.

Example from Caribbean 1 VFR Aeronautical Chart

## Airport Traffic Service and Airport Space Information Unique to CAC

Only airway and reserved airspace effective below 18,000' MSL in the U.S. airspace and below FL200 outside of the U.S. airspace are shown.

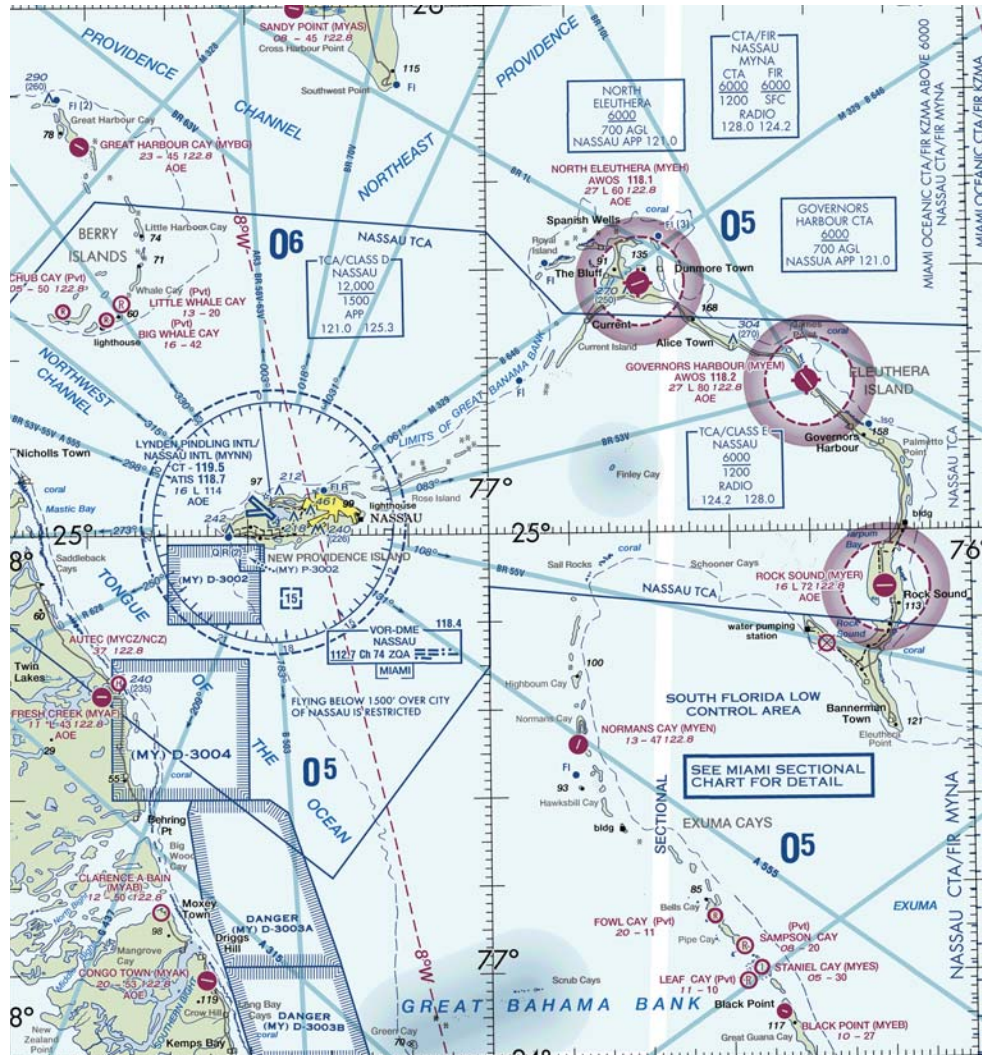

# VFR SECTIONAL AND TERMINAL AREA CHARTS

## GENERAL INFORMATION

The symbols shown in this section illustrate those that appear in the Sectional Aeronautical Charts (Sectionals) and Terminal Area Charts (TACs). The same symbology is utilized in VFR Flyway Planning Charts, Helicopter Route Charts and Caribbean Aeronautical Charts (CACs), however the scale of the symbols may be different due to the particular chart scales. Where symbology is distinctive to a given chart, examples and explanations are given in the additional examples.

## AIRPORTS

### Landplane: Civil

Airports having control towers (CT) are shown in blue, all others are shown in magenta.

All recognizable runways, including some which may be closed, are shown for visual identification purposes. Fuel available.

Runway patterns will be depicted at airports with at least one hard surfaced runway 1500' or greater in length.

Non-Towered      Towered

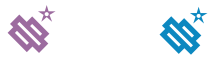

### Landplane: Civil-Military

Non-Towered      Towered



### Landplane: Military

Non-Towered      Towered

Refueling and repair facilities not indicated.



### Heliport

(Selected)

Non-Towered      Towered



### Seaplane: Civil

Non-Towered      Towered



### Ultralight Flight Park

(Selected)



### Landplane: Emergency

Fuel not available  
or

Complete information  
is not available.



**PUBLIC USE** - (Soft surfaced runway, or hard surfaced runway less than 1500' in length.) Fuel not available.



**RESTRICTED OR PRIVATE** - (Soft surfaced runway, or hard surfaced runway less than 1500' in length.) Use only in emergency, or by specific authorization.



**OBJECTIONABLE**

**OBJECTIONABLE** is an airport that has an airspace determination based upon a number of factors including conflicting traffic patterns with another airport, hazardous runway conditions, or natural or man-made obstacles in close proximity to the landing area.



**UNVERIFIED** - A landing area available but warranting more than ordinary precaution due to:

(1) lack of current information on field conditions,

and/or

(2) available information indicates peculiar operating limitations.



Appropriate note as required for hard surfaced runways only: "(CLOSED)"

**ABANDONED** - Depicted for landmark value or to prevent confusion with an adjacent usable landing area. (Normally at least 3000' paved).

### Seaplane: Emergency

Fuel not available or complete information is not available.



# AIRPORTS (Continued)

## Airport Data Grouping

(Pvt): Non-public use having emergency or landmark value.

“OBJECTIONABLE”: This airport may adversely affect airspace use.

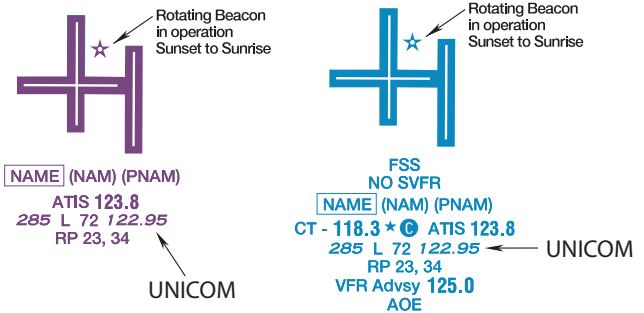

FAA Chart Users' Guide - VFR Symbolology - Sectional and Terminal Area Charts

Flight Service Station on field	FSS	Elevation in feet	285
Airports where fixed wing special VFR operations are prohibited (shown above airport name) FAR 91	NO SVFR	Lighting in operation Sunset to Sunrise	L
Indicates FAR 93 Special Air Traffic Rules and Airport Traffic Pattern		Lighting limitations exist; refer to Chart Supplement	*L
Location Identifier	(NAM)	Length of longest runway in hundreds of feet; usable length may be less.	72
ICAO Location Identifier	(PNAM)	Aeronautical advisory station	122.95
Control Tower (CT) - primary frequency	CT - 118.3	Runways with Right Traffic Patterns (public use)	RP 23,34
Star indicates operation part-time. See tower frequencies tabulation for hours of operation	*	See Chart Supplement	*RP
Follows the Common Traffic Advisory Frequency (CTAF)	C	VFR Advisory Service Shown when ATIS is not available and frequency is other than the primary CT frequency.	VFR Advsy 125.0
Automatic Terminal Information Services	ATIS 123.8	Weather Camera (Alaska)	WX CAM
Automatic Flight Information Service	AFIS 135.2	Airport of Entry	AOE
Automated Surface Weather Observing Systems; shown when full-time ATIS is not available.	ASOS/AWOS 135.42	When information is lacking, the respective character is replaced by a dash. Lighting codes refer to runway edge lights and may not represent the longest runway or full length lighting.	



# RADIO AIDS TO NAVIGATION

## VOR

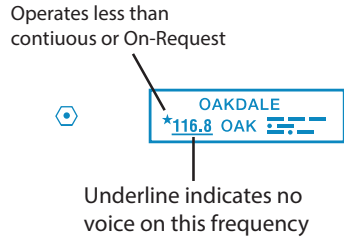

## VORTAC

When an NDB NAVAID shares the same name and Morse Code as the VOR NAVAID the frequency can be collocated inside the same box to conserve space.

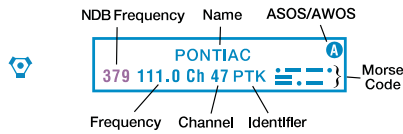

## VOR-DME

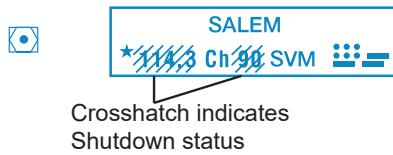

## DME

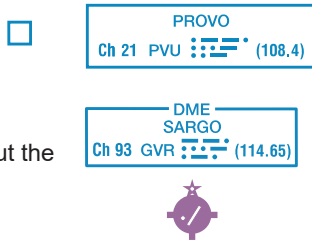

DME co-located at an airport  
Note: DMEs are shown without the compass rose.

## Compass Rose

Compass Rose is "reference" oriented to magnetic north

Example of VOR NAVAID co-located at airport

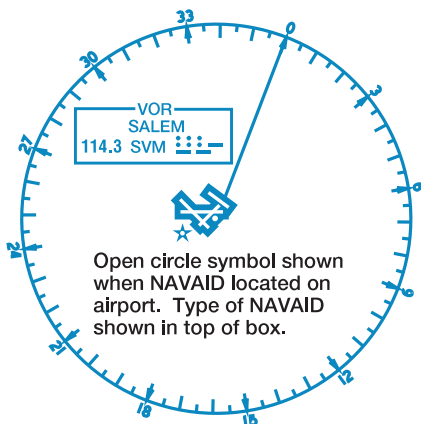

## Non-Directional Radio Beacon (NDB)

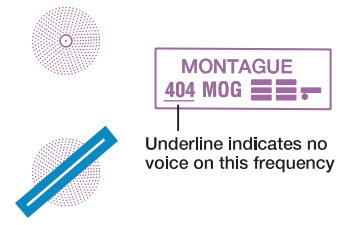

## NDB-DME

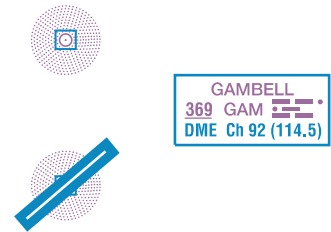

## NAVAID Used To Define Class B Airspace

### ILS Components

#### ILS-DME

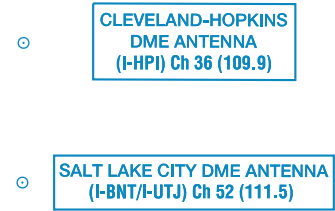

TAC - Shown when used in description of Class B airspace.

## Compass Rosette

Shown only in areas void of VOR roses.

Compass rosette will be based on the five year epoch magnetic variation model.

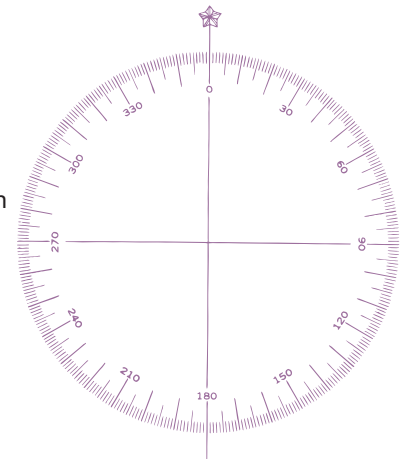

# RADIO AIDS TO NAVIGATION (Continued)

## Automated Weather Broadcast Services

Automated Weather Observing System (AWOS) / Automated Surface Observing System (ASOS).



## Flight Service Station (FSS)

Heavy line box indicates Flight Service Station (FSS). Frequencies 121.5, 122.2, 243.0 and 255.4 (Canada - 121.5, 126.7, and 243.0) are normally available at all FSSs and are not shown above boxes. All other frequencies are shown. Frequencies transmit and receive except those followed by an R.

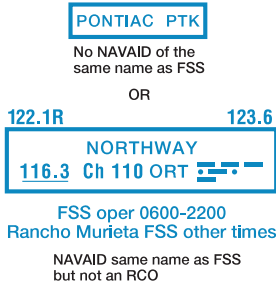

R - receive only

## International Flight Service Station

## Off Airport AWOS/ASOS



## Broadcast Stations (BS)

On request by the proper authority or when a VFR Checkpoint



## Remote Communications Outlet (RCO)

Frequencies above thin line box are remot to NAVAID site. Other frequencies at FSS providing voice communication may be available determined by altitude and terrain. Consult Chart Supplement for complete information.

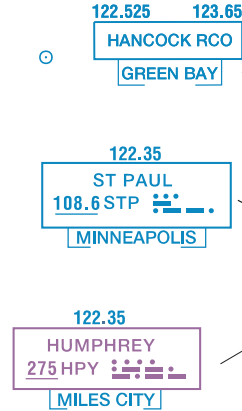

FSS Radio providing voice communications

Thin line box without frequencies and controlling FSS name indicates no FSS frequency available.

# AIRSPACE INFORMATION

## Class B Airspace

### Sectional

LAS VEGAS CLASS B



Appropriate notes as required may be shown.

Only the airspace effective below 18,000 feet MSL are shown.

(Mode C see FAR 91.215 / AIM)

## Terminal Area Chart (TAC)

LAS VEGAS CLASS B

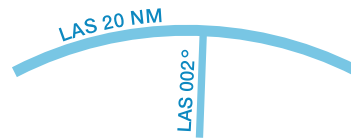

CTC LAS VEGAS APP  
ON 121.1 OR 257.8

All mileages are nautical (NM).

All radials are magnetic.

# AIRSPACE INFORMATION (Continued)

## Class C Airspace

Appropriate notes as required may be shown.

(Mode C see FAR 91.215/ AIM)

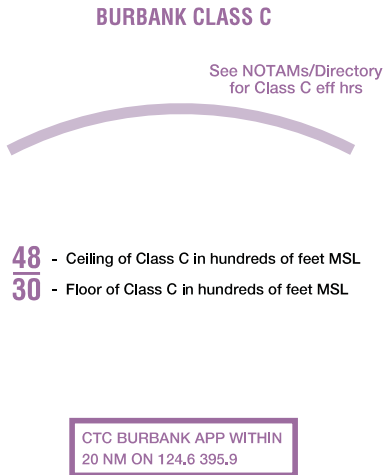

## Class E Airspace

The limits of Class E airspace shall be shown by narrow vignettes or by the dashed magenta symbol. Individual units of designated airspace are not necessarily shown; instead, the aggregate lateral and vertical limits shall be defined by the following:

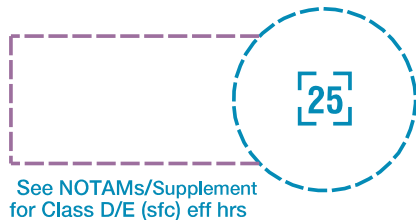

Airspace beginning at the surface (sfc) designated around airports..

Airspace beginning at 700 feet AGL that laterally abuts 1200 feet or higher Class E Airspace...



Airspace beginning at 700 feet AGL that laterally abuts uncontrolled (Class G) airspace...



Airspace beginning at 1200 feet AGL that laterally abuts uncontrolled (Class G) airspace...



Differentiates floors of airspace greater than 700 feet above the surface...

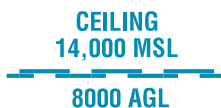

When the ceiling is less than 18,000 feet MSL, the value prefixed by the word "CEILING", shall be shown along the limits.

## Class D Airspace

Altitude in hundreds of feet MSL

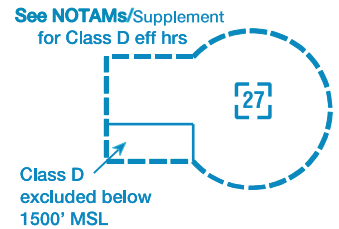

(A minus in front of the figure is used to indicate "from surface to but not including...")



Airspace beginning at the surface (sfc) designated around airports...



Airspace beginning at the surface with an airspace exclusion area where Class E airspace is excluded below 1200' MSL.

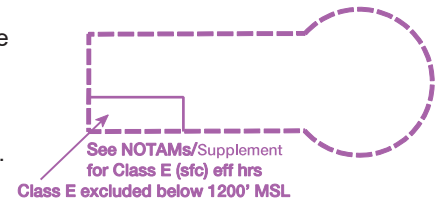

# AIRSPACE INFORMATION (Continued)

## Class E Airspace (Continued)

### Low Altitude Airways VOR and LF/MF (Class E Airspace)

Low altitude Federal Airways are indicated by centerline.

Only the controlled airspace effective below 18,000 feet MSL is shown

### Miscellaneous Air Routes

Combined Federal Airway/RNAV 2 "T" Routes are identified in solid blue type adjacent to the solid magenta federal airway identification.

The joint route symbol is screened magenta.

### Canadian Airspace

Individual units of designated Canadian airspace are not necessarily shown; instead, the aggregate lateral and vertical limits shall be portrayed as closely as possible to the comparable U.S. airspace.

Appropriate notes as required may be shown

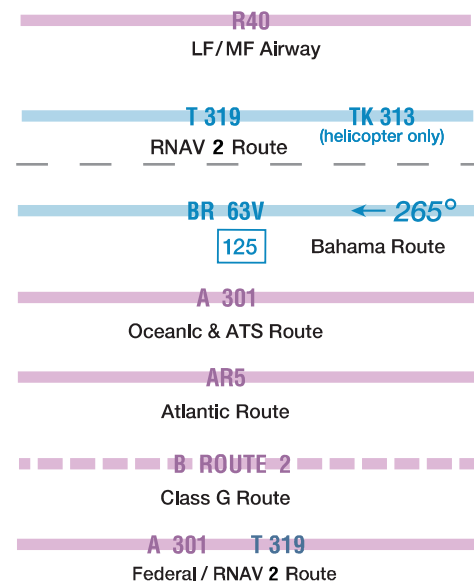
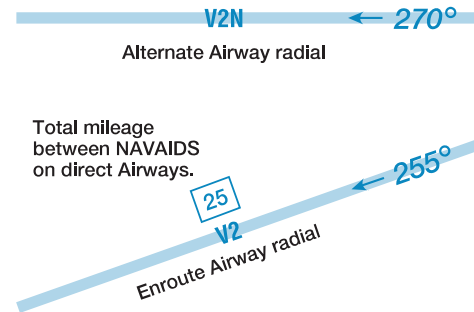
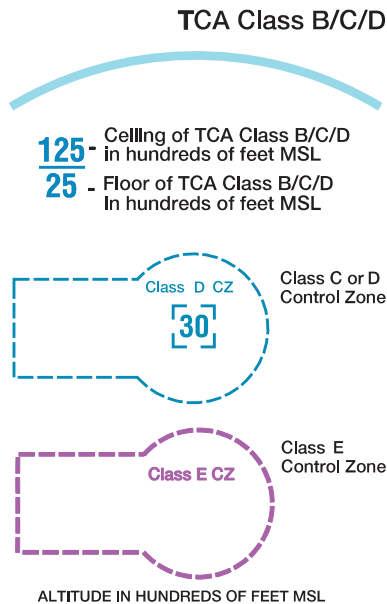

### Flight Information Regions (FIR)



### Oceanic Control Areas (OCA)



### Control Areas (CTA)

### Offshore Control Areas



# AIRSPACE INFORMATION (Continued)

## Special Conservation Areas

National Park, Wildlife Refuge, Primitive and Wilderness Areas, etc.



NOAA Regulated National Marine Sanctuary  
Designated Areas



Flight operations below 1000' AGL over the designated areas within the Gulf of Farallones National Marine Sanctuary violate NOAA regulations (see 15 CFR 922).

## Special Flight Rules Area (SFRA) Relating to National Security

Example: Washington DC

Appropriate notes as required may be shown.

Note: Delimiting line not shown when it coincides with International Boundary, projection lines or other linear features.

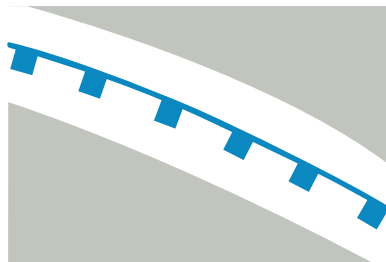

WASHINGTON DC METROPOLITAN AREA SFRA

Washington DC Metropolitan Area Special Flight Rules Area/Flight Restricted Zone (DC SFRA & DC FRZ) (See description in Atlantic Ocean).

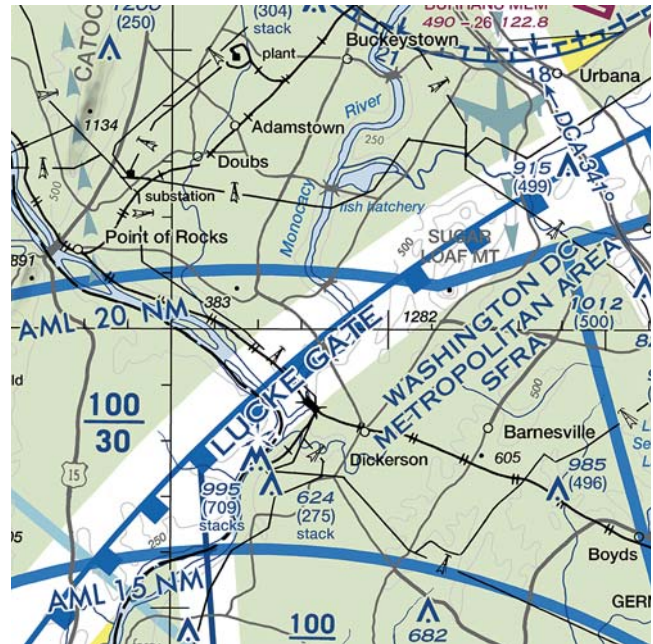

## Temporary Flight Restriction (TFR) Relating to National Security

Example: Washington DC

Appropriate notes as required may be shown.

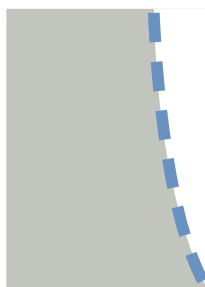

CAUTION  
CONTACT FLIGHT SERVICE FOR LATEST FLIGHT RESTRICTION STATUS AND NOTAMS ASSOCIATED WITH P-40 AND R-4009

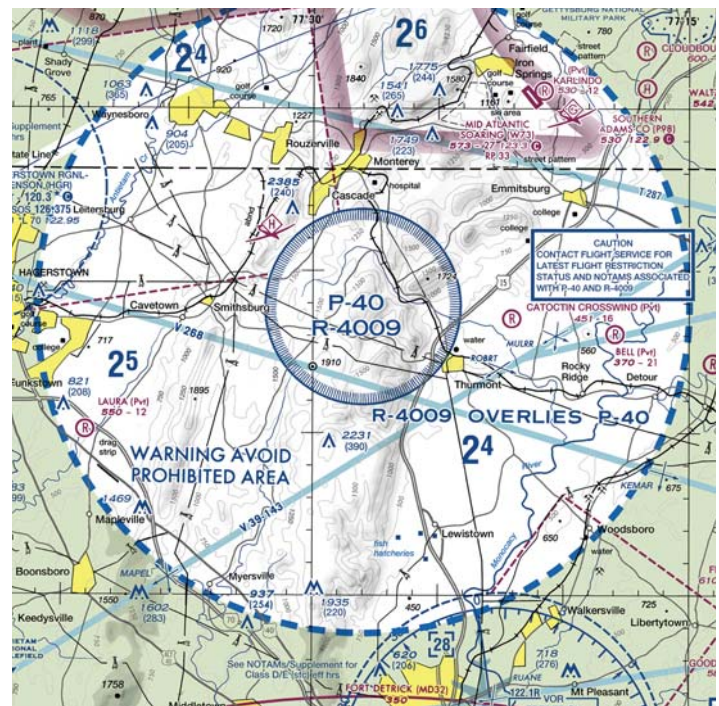

# AIRSPACE INFORMATION (Continued)

## Special Flight Rules Area (SFRA)



**SPECIAL FEDERAL AVIATION REGULATIONS (SFAR)**  
 14 CFR Part 93, Subpart U and SFAR 50.2 - GRAND CANYON NATIONAL PARK SPECIAL FLIGHT RULES AREA. Special regulations apply to all aircraft operations below 18,000 feet MSL.

## Special Use Airspace

Only the airspace effective below 18,000 feet MSL is shown.

The type of area shall be spelled out in large areas if space permits.

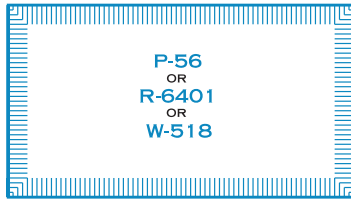

**PROHIBITED, RESTRICTED or WARNING AREA**

\* Alert Areas do not extend into Class A, B, C and D airspace, or Class E airport surface areas.



**ALERT AREA**



**MILITARY OPERATIONS AREA (MOA)**

## Special Air Traffic Rules / Airport Patterns (FAR Part 93)

Appropriate boxed note as required shown adjacent to area.



**SPECIAL NOTICE**  
 Pilots are required to obtain an ATC clearance prior to entering this area.

## Flight Restricted Zone (FRZ) Relating to National Security

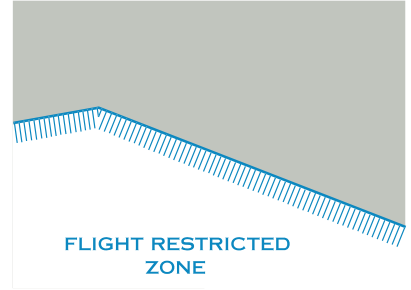

**FLIGHT RESTRICTED ZONE**

## National Security Area

Appropriate notes as required may be shown



Small Area

**NOTICE**  
 FOR REASONS OF NATIONAL SECURITY PILOTS ARE REQUESTED TO AVOID FLIGHT BELOW 1200' MSL IN THIS AREA

## Special Awareness Training Areas



**NOTICE**  
 Special awareness training required within 60 NM of DCA VOR-DME. See description on Flyway.

## Mode C (FAR 91.215)

Appropriate notes as required may be shown.

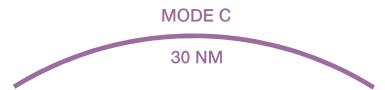

## Air Defense Identification Zone (ADIZ)

Note: Delimiting line not shown when it coincides with International Boundary, projection lines or other linear features.



# AIRSPACE INFORMATION (Continued)

## High Energy Radiation Areas

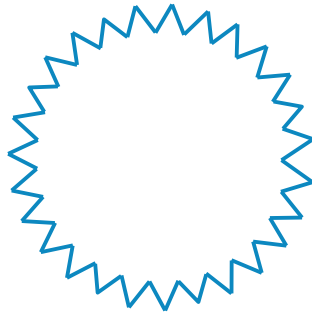

Appropriate notes as required may be shown.

Solar Farm-Ocular Glare

## Military Training Routes (MTR)

← VR269

## Special Military Activity Routes (SMAR)

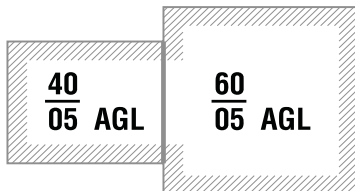

Boxed notes shown adjacent to route.

SPECIAL MILITARY ACTIVITY  
CTC ALBUQUERQUE CNTR ON 135.875  
FOR ACTIVITY STATUS

40 / 05 AGL

## IFR Routes

Arrival

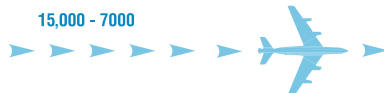

Departure



Arrival/Departure



TAC only

## Special Security Notice Permanent Continuous Flight Restriction Areas

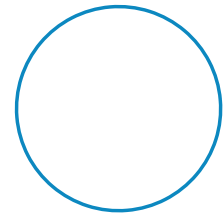

DISNEYLAND THEME PARK  
See Note for requirements

## Sporting Event Temporary Flight Restriction (TFR) Sites



## Space Operations Area (FAR Part 91.143)

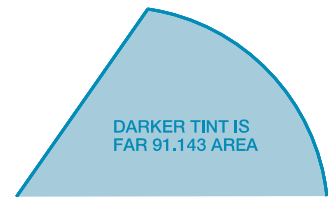

## Miscellaneous Activity Areas

Aerobatic Practice Area



Glider Operations



Hang Glider Activity



Ultralight Activity



Unmanned Aircraft Activity



Parachute Jumping Area with Frequency



Space Launch Activity Area



# AIRSPACE INFORMATION (Continued)

## VFR Transition Routes

Appropriate notes as required may be shown.

VFR TRANSITION ROUTE  
ATC CLEARANCE REQUIRED  
SEE SHOWBOAT GRAPHIC  
ON SIDE PANEL

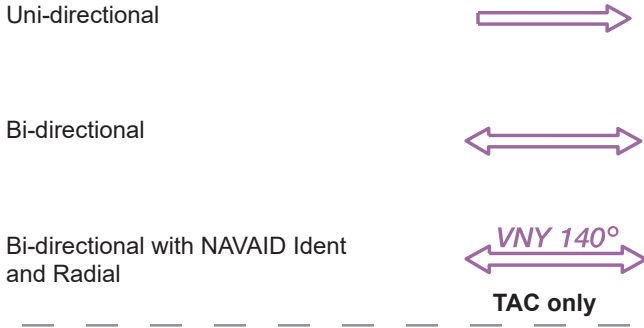

Example: Los Angeles



## Terminal Radar Service Area (TRSA)

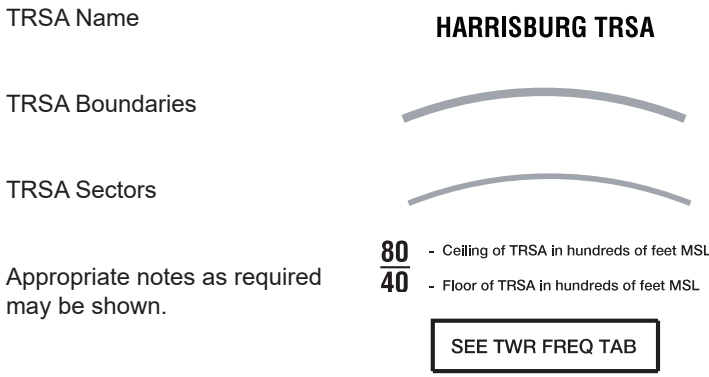

Example: Harrisburg, PA



## NAVIGATIONAL AND PROCEDURAL INFORMATION

### Isogonic Line and Value

Isogonic lines and values shall be based on the five year epoch magnetic variation model.

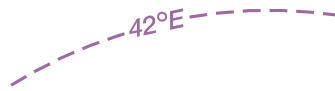

### Local Magnetic Notes

Unreliability Notes

Magnetic disturbance of as much as 78° exists at ground level and 10° or more at 3000 feet above ground level in this vicinity.

### Intersections

Named intersections used as reporting points. Arrows are directed toward facilities which establish intersection.

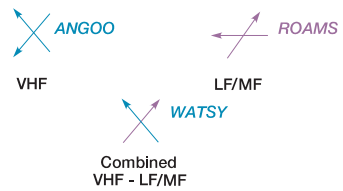

### Aeronautical Lights

By Request

Rotating or Oscillating 

Isolated Location 

Rotating Light with Flashing Code Identification Light

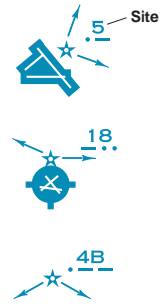

Rotating Light with Course Lights and Site Number





FAA Chart Users Guide - VFR Symbology - Sectional and Terminal Area Charts



# NAVIGATIONAL AND PROCEDURAL INFORMATION (Continued)

## Airport Beacons

Rotating or Flashing   

Isolated Locations 

## VFR Checkpoints

Underline indicates proper name of VFR Checkpoint.

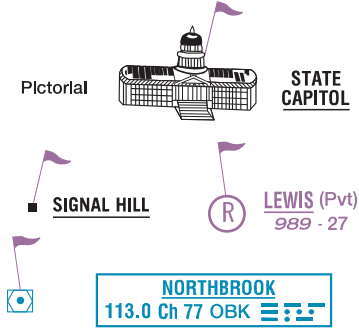

## VFR Waypoints

RNAV 

Stand-Alone 

Collocated with VFR Checkpoint 

## Obstruction

Above 200' & below 1000' AGL (above 299' AGL in urban area) 

Under Construction (UC) or reported and position/elevation unverified 

1000' and higher (AGL) 

Wind Turbine 

## High-Intensity Obstruction Lights

Less than 1000' (AGL) 

1000' and higher (AGL) 

Wind Turbine 

Group obstruction 

Wind Turbines 

High-intensity lights may operate part-time or by proximity activation.

## Marine Lights

With Characteristics of Light

Red	R
White	*W
Green	G
Blue	BU
Orange	OR
Black	B
Yellow	Y
Sector	SEC
Fixed	F
Single Occulting	Oc
Group Occulting	Oc (2)
Composite Group Occulting	Oc (2+1)
Isophase	Iso
Flashing	FI
Group Flashing	FI (2)
Composite Group Flashing	FI (2+1)
Quick	Q
Interrupted Quick	IQ
Morse Code	Mo (A)
Fixed and Flashing	FFI
Alternating	AI
Group	Gp
Long Flash	LFI
Group Quick Flashing	Q (3)
Interrupted Quick Flashing	IQ
Very Quick Flashing	VQ
Group Very Quick Flashing	VQ (3)
Interrupted Very Quick Flashing	IVQ
Ultra Quick Flashing	UQ
Interrupted Ultra Quick Flashing	IUQ

Oc  
R SEC  
Land Light

**\* Marine Lights are white unless otherwise noted. Alternating lights are red and white unless otherwise noted.**

## Group Obstruction

Above 200' & below 1000' AGL (above 299' AGL in urban area) 

1000' and higher (AGL) 

At least two in group 1000' and higher (AGL) 

Wind Turbines 

## Wind Turbine Farms

When highest wind turbine is unverified, UC will be shown after MSL value.



## Maximum Elevation Figure (MEF)

(see VFR Terms tab for explanation)

# NAVIGATIONAL AND PROCEDURAL INFORMATION (Continued)

## Chart Limits

### Outline on Sectional of Terminal Area Chart



**LOS ANGELES TERMINAL AREA**  
Pilots are encouraged to use the Los Angeles VFR Terminal Area Chart for flights at or below 10,000'

### Outline of Special Chart on Sectional and Terminal Area Chart



### Outline on Sectional of Inset Chart



If Inset chart is on the same chart as outline:

**INDIANAPOLIS INSET**  
See inset chart for additional detail

If inset chart is on a different chart:

**INDIANAPOLIS INSET**  
See inset chart on the St. Louis Sectional for additional information

## CULTURE

### Railroads

Single Track

Double Track

More Than Two Tracks

Electric

Non-operating, Abandoned or Under Construction

### Roads

Dual-Lane Divided Highway Category 1

Primary Category 2

Secondary Category 2

### Trails

Category 3

Provides symbolization for dismantled railroad when combined with label "dismantled railroad."

### Railroad Yards

Limiting Track To Scale

Location Only

### Railroad Stations

### Railroad Sidings and Short Spurs

### Road Markers

Interstate Route No.

U.S. Route No.

Air Marked Identification Label

### Road Names

### Roads Under Construction

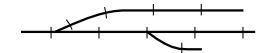
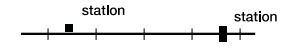
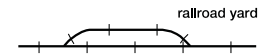

# CULTURE (Continued)

## Related Features to Railroads and Roads

### Bridges and Viaducts

Railroad

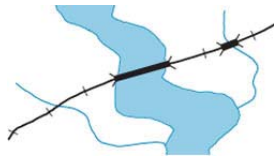

### Bridges and Viaducts

Road

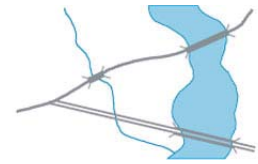

### Causeways



### Ferries, Ferry Slips and Fords

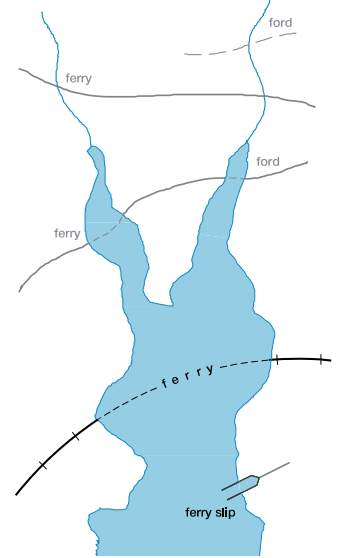

### Overpasses and Underpasses



### Tunnels-Road and Railroad



## Populated Places

Yellow tinted areas indicate populated places.

Small circle indicates an area too small to depict using yellow tint.



Font Style and Size indicate the category of the populated area:

Large Cities Category 1  
- population more than 250,000

ST LOUIS

Cities and Large Towns Category 2  
- population 25,000 to 250,000

NASHVILLE

Towns and Villages Category 3  
- population less than 25,000

Frankfort

# CULTURE (Continued)

## BOUNDARIES

### International



### State or Province



### Convention or Mandate Line

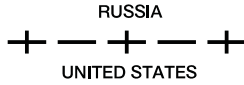

## Miscellaneous Cultural Features

### Dams

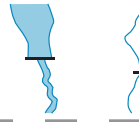

### Passable Locks



### Weirs and Jetties

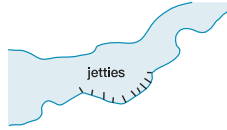

### Breakwaters

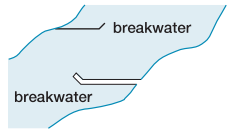

### Pipelines

pipeline

### Underground

underground pipeline

### Landmark Features

- substation
- fort
- cemetery

### Mines or Quarries

### Shaft Mines or Quarries



### Wells

### Other than water

oil

### Lookout Towers (Elevation Base of Tower)



### Aerial Cableways, Conveyors, Etc.

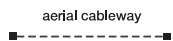

## Time Zones

PST (+7DT) = UTC  
 .....  
 MST (+6DT) = UTC

## Date Line



## Dam Carrying Road



## Small Locks

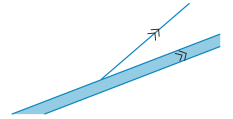

## Seawalls

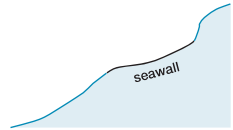

## Piers, Wharfs, Quays, etc.

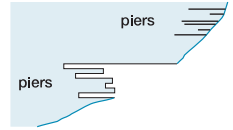

## Power Transmission and Telecommunication Lines



## Tanks

- water
- oil
- gas

## Outdoor Theater



## Race Tracks



## Coast Guard Station

CG

## Landmark Areas

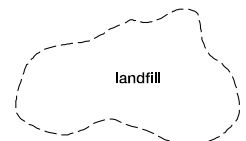

# HYDROGRAPHY

## Open Water



## Open/Inland Water

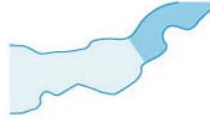

## Lakes

Label as required.



## Perennial

When too numerous to show individual lakes, show representative pattern and descriptive note. Number indicates elevation.



## Non-Perennial

(dry, intermittent, etc.) Illustration includes small perennial lake.

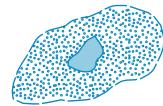

## Reservoirs

Natural Shorelines

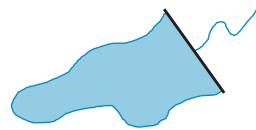

Man-made Shorelines

Label when necessary for clarity



Too small to show to scale



Under Construction

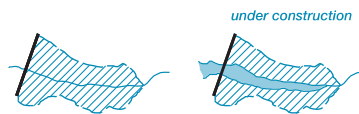

## Inland Water



## Shorelines

Definite



Fluctuating



Unsurveyed  
Indefinite



Man-made



# HYDROGRAPHY (Continued)

## Streams

Perennial	
Non-Perennial	
Fanned Out	
Alluvial fan	
Braided	
Disappearing	
Seasonally Fluctuating with undefined limits	
with maximum bank limits, prominent and constant	
Sand Deposits in and along riverbeds	

## Wet Sand Areas

Within and adjacent to desert areas	
-------------------------------------	--

## Aqueducts

To Scale	
Abandoned or Under Construction	
Underground	

## Falls

Double-Line	
Single-Line	

## Canals

To Scale	
Abandoned or Under Construction	
Abandoned to Scale	

## Small Canals and Drainage / Irrigation Ditches

Perennial	
Non-Perennial	
Abandoned or Ancient Numerous	
Representative pattern and/or descriptive note.	

## Suspended or Elevated

Tunnels	
Kanats Underground with Air Vents	

## Rapids

Double-Line	
Single-Line	

# HYDROGRAPHY (Continued)

## Salt Evaporators and Salt Pans Man Exploited

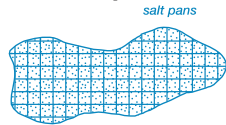

salt pans

## Hummocks and Ridges

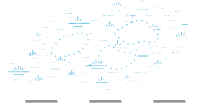

## Peat Bogs



peat bog

## Rice Paddies



Extensive areas indicated by label only.

## Springs, Wells and Waterholes



## Swamps, Marshes and Bogs

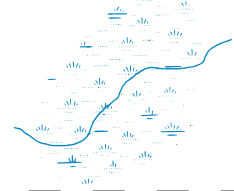

## Mangrove And Nipa



## Cranberry Bogs

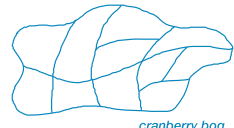

cranberry bog

## Land Subject To Inundation



## Tundra

tundra

## Permanent Snow and Ice Areas

### Glaciers

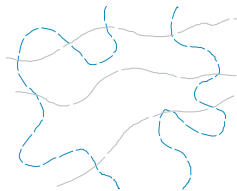

### Glacial Moraines

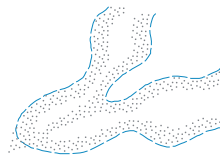

### Ice Cliffs

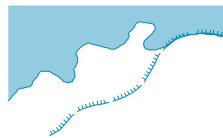

### Snowfields, Ice Fields And Ice Caps

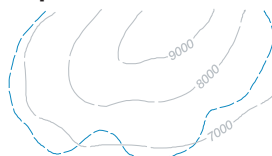

### Foreshore Flats

Tidal flats exposed at low tide.

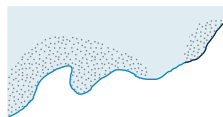

## Ice

Permanent Polar Ice

Pack Ice

Ice Peaks



# HYDROGRAPHY (Continued)

## Reefs-Rocky or Coral

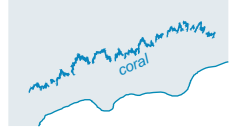

## Fish Ponds and Hatcheries

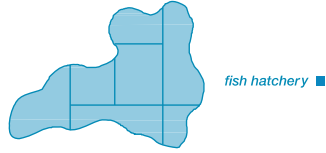

## RELIEF

### Contours

Basic



Approximate



Intermediate



Auxiliary



Depression  
(Illustration includes mound within depression)

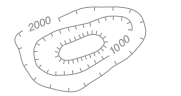

Values



## Sand or Gravel Areas



## Sand Dunes

To Scale

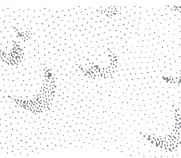

## Hachuring



## Miscellaneous Underwater Features Not Otherwise Symbolized

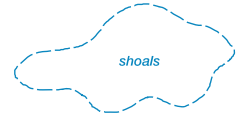

## Wrecks

Exposed



## Rocks-Isolated

Bare or Awash



## Spot Elevations

Position Accurate



Position Accurate, Elevation Approximate

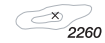

Highest in General Area



Highest on Chart



## Mountain Pass



## Distorted Surface Areas

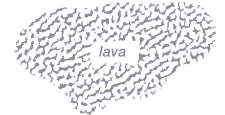

## Lava Flows



## Sand Ridges

To Scale



## Shaded Relief





# RELIEF (Continued)

## Quarries To Scale



## Craters

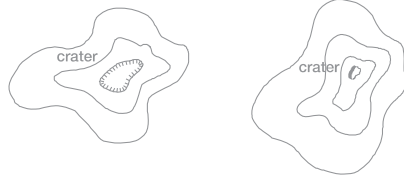

## Unsurveyed Areas

Label appropriately as required

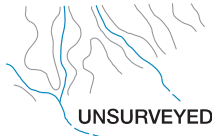

## Levees And Eskers



## Rock Strata Outcrop



## Strip Mines, Mine Dumps And Tailings

To Scale



## Escarpments, Bluffs, Cliffs, Depressions, Etc.

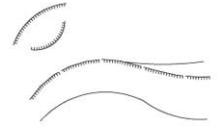

## Uncontoured Areas

Label appropriately as required

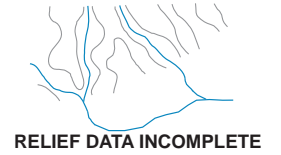



# VFR FLYWAY PLANNING CHARTS

## GENERAL INFORMATION

**VFR Flyway Planning Charts** are printed on the reverse sides of the Baltimore-Washington, Charlotte, Chicago, Cincinnati, Dallas-Ft. Worth, Denver, Detroit, Houston, Las Vegas, Los Angeles, Miami, Orlando, New Orleans, Phoenix, St. Louis, Salt Lake City, San Diego, San Francisco and Seattle Terminal Area Charts (TACs). The scale is 1:250,000, with area of coverage the same as the associated TACs. Flyway Planning Charts depict flight paths and altitudes recommended for use to by-pass areas heavily traversed by large turbine-powered aircraft. Ground references on these charts provide a guide for visual orientation. VFR Flyway Planning charts are designed for use in conjunction with TACs and are not to be used for navigation.

## AIRPORTS

### Landplane

No distinction is made between airports with fuel and those without fuel. Runways may be exaggerated to clearly portray the pattern. Hard-surfaced runways which are closed but still exist are included in the charted pattern.

FAR 91 - Fixed wing special VFR operations prohibited.

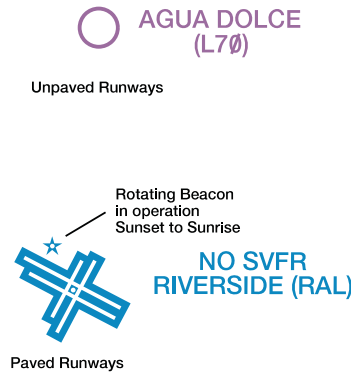

### Landplane (continued)

(Pvt): Non-public use having emergency or landmark value.



“OBJECTIONABLE”: This airport may adversely affect airspace use.



ABANDONED - Depicted for landmark value or to prevent confusion with an adjacent usable landing area. Only portrayed beneath or close to the VFR flyway routes or requested by the FAA. (Normally at least 3000' paved).



## RADIO AIDS TO NAVIGATION

### VHF Omni-Directional Radio Range (VOR)



### VORTAC



### VOR-DME



### DME



Example: DME co-located at an airport.



### Non-Directional Radio Beacon (NDB)



### NDB-DME



### NAVAIDS Used to Define Class Airspace

ILS - DME



Shared ILS - DME



# AIRSPACE INFORMATION

## Class B Airspace

Appropriate notes as required may be shown.

(Mode C see FAR 91.215/AIM)

All mileages are nautical (NM).

All radials are magnetic.

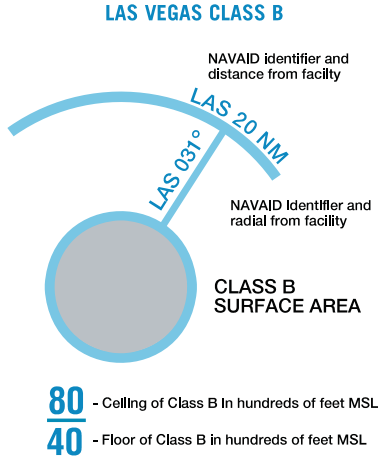

Floors extending “upward and above” a certain altitude are preceded by a +. Operations at or below these altitudes are outside of the Class B Airspace.)

## Class D Airspace

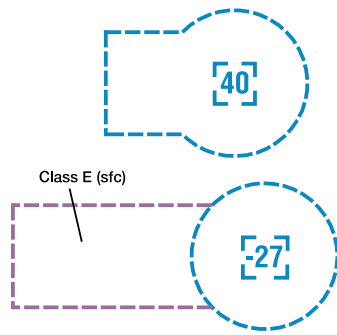

(A minus sign in front of the figure used to indicate “from surface to but not including...”)

ALTITUDE IN HUNDREDS OF FEET MSL.

## Special Airspace Areas

### Special Flight Rules Area (SFRA) Relating to National Security

Example: Washington DC

Appropriate notes as required may be shown.

Note: Delimiting line not shown when it coincides with International Boundary, projection lines or other linear features.

## Class C Airspace

Appropriate notes as required may be shown.

(Mode C see FAR 91.215/AIM)

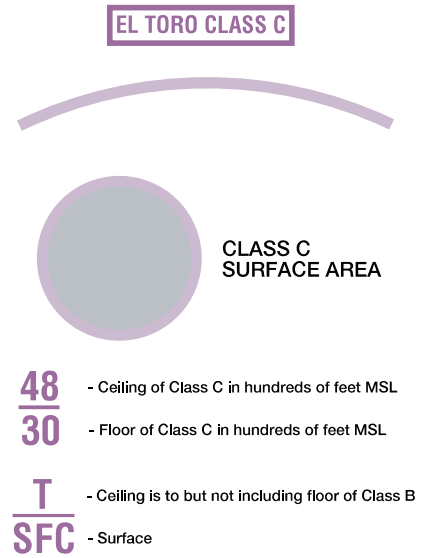

## Class E Surface (SFC) Airspace

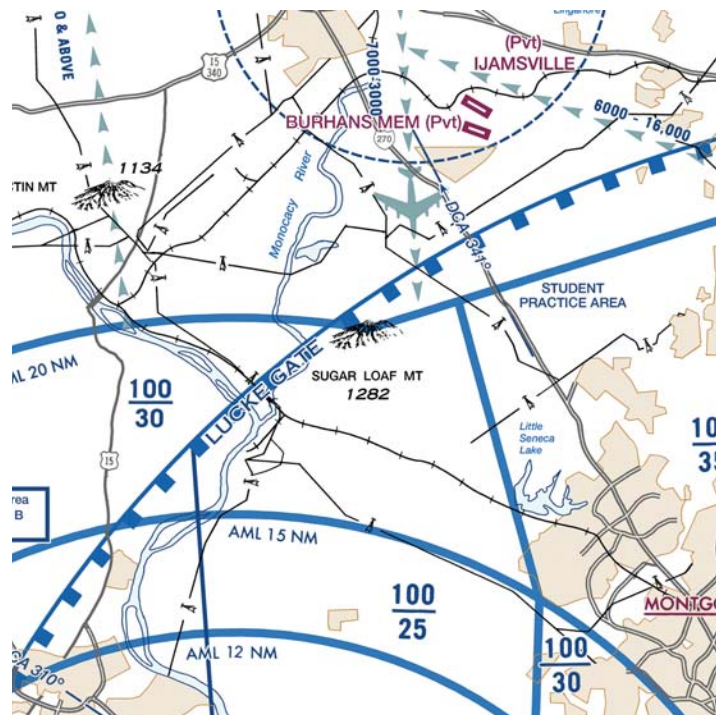
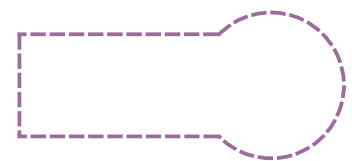

## AIRSPACE INFORMATION (Continued)

### Flight Restricted Zone (FRZ) Relating To National Security

Example: Washington DC

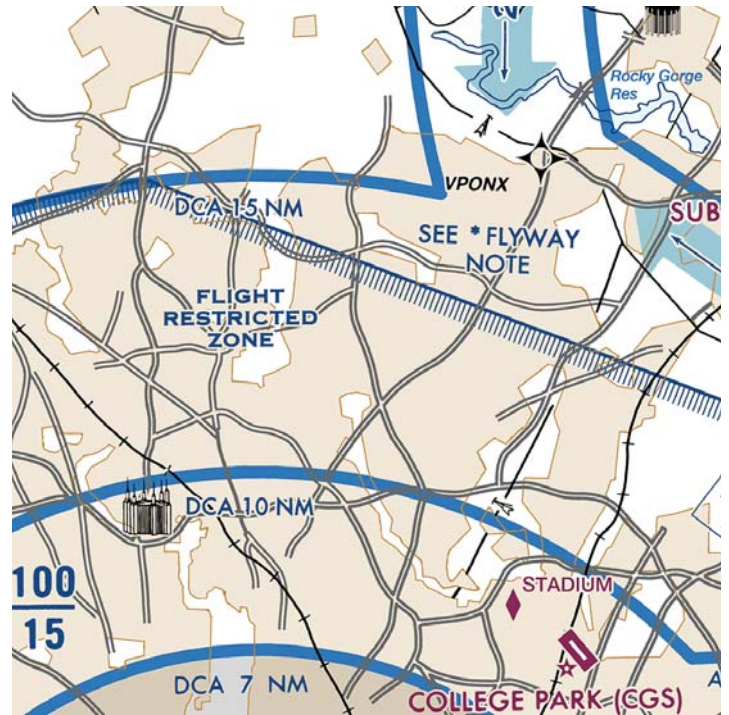

### Temporary Flight Restriction (TFR) Relating To National Security

Example: Washington DC

Appropriate notes as required may be shown.

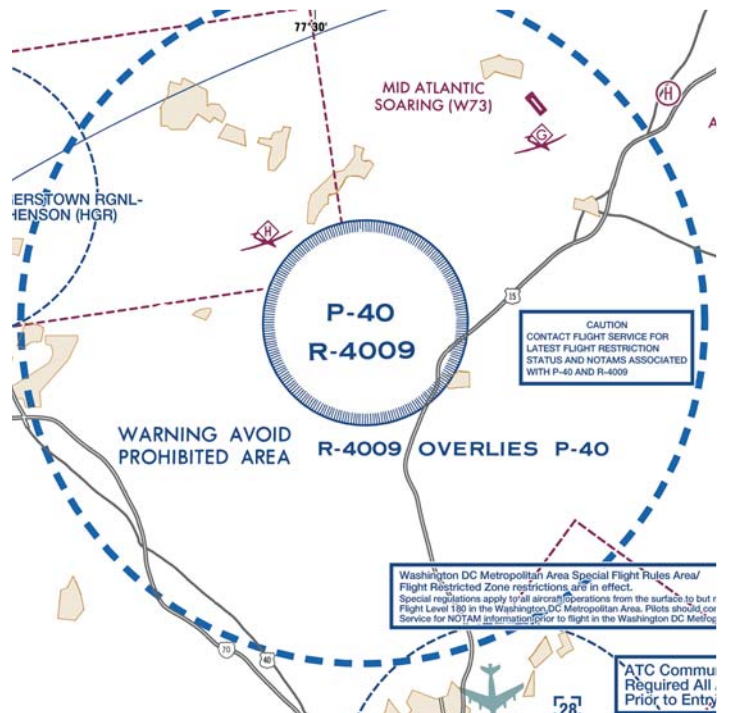

### Special Use Airspace

Only the airspace effective below 18,000 feet MSL is shown.

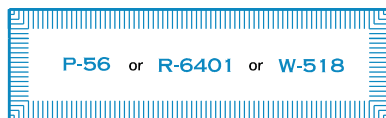

PROHIBITED, RESTRICTED or WARNING AREA

The type of area shall be spelled out in large areas if space permits.

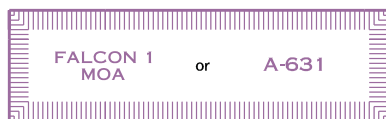

MILITARY OPERATIONS AREA (MOA) or ALERT AREA

### Air Defense Identification Zone (ADIZ)

Note: Delimiting line not shown when it coincides with International Boundary, projection lines or other linear features.



# AIRSPACE INFORMATION (Continued)

## Special Air Traffic Rules/Airport Traffic Areas (FAR Part 93)

Appropriate boxed note as required shown adjacent to area.



## Terminal Radar Service Area (TRSA)

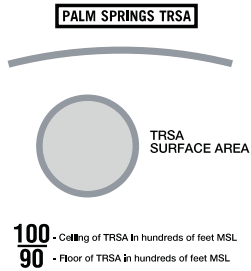

## IFR Routes

Arrival



Departure



Arrival/Departure



## VFR Transition Routes

Appropriate notes as required may be shown.

VFR TRANSITION ROUTE  
ATC CLEARANCE REQUIRED  
SEE SHOWBOAT GRAPHIC  
ON SIDE PANEL

Uni-directional



Bi-directional



Bi-directional with NAVAID Ident and Radial



## Special Conservation Areas

NOAA Regulated National Marine Sanctuary Designated Areas



Flight operations below 1000' AGL over the designated areas within the Gulf of Farallones National Marine Sanctuary violate NOAA regulations (see 15 CFR 922).

## Mode C (FAR 91.215)

Appropriate notes as required may be shown.

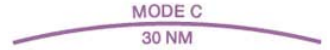

## Sporting Event Temporary Flight Restriction (TFR) Sites



## Miscellaneous Activity Areas

Aerobatic Practice Area



Glider Operations



Hang Glider Activity



Ultralight Activity



Unmanned Aircraft Activity



Parachute Jumping Area with Frequency



Space Launch Activity Area



Example: Los Angeles



## Suggested VFR Flyway And Altitude

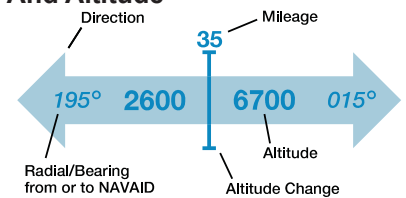

## Military Training Routes (MTR)



# NAVIGATIONAL AND PROCEDURAL INFORMATION

## VFR Checkpoints

Underline indicates proper name of VFR Checkpoint

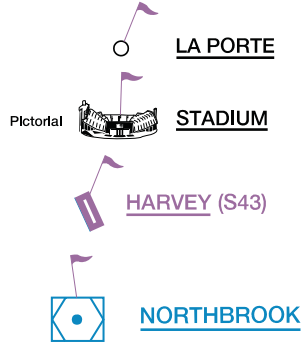

## VFR Waypoints

Stand-Alone

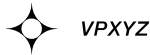

Collocated with VFR Checkpoint



## Navigational Data

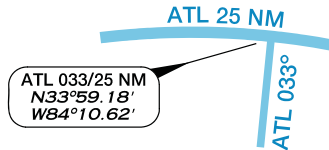

## CULTURE

### Railroads

Single and Multiple Tracks



### Populated Places

Built-up Areas

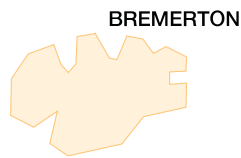

Towns



## BOUNDARIES

International



## Obstructions

Only obstacles greater than 999' above ground level (AGL) or specified by the local ATC Facility shall be shown.

AGL heights are not shown. High-intensity lights may operate part-time or by proximity activation.

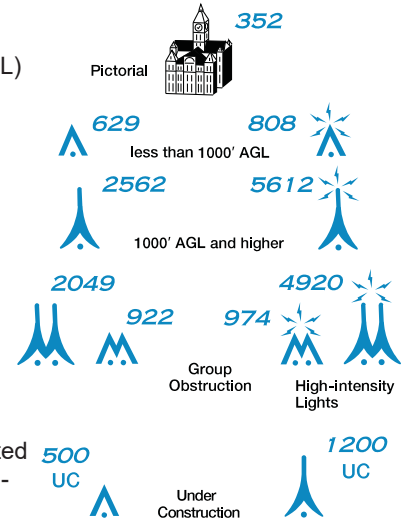

Under Construction or reported and position/elevation unverified.

### Roads

### Roads

Dual-Lane



Divided Highway Primary

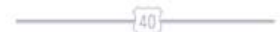

### Prominent Pictorials



### Power Transmission Lines



### Landmarks



# HYDROGRAPHY

## Shorelines



## Reservoirs

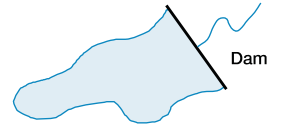

## Major Lakes and Rivers



# RELIEF

## Spot Elevations

Position Accurate  
Mountain Peaks





# HELICOPTER ROUTE CHARTS

## GENERAL INFORMATION

**Helicopter Route Charts** are three-color charts that depict current aeronautical information useful to helicopter pilots navigating in areas with high concentrations of helicopter activity. Information depicted includes helicopter routes, four classes of heliports with associated frequency and lighting capabilities, NAVAIDS, and obstructions. In addition, pictorial symbols, roads, and easily-identified geographical features are portrayed. The scale is 1:125,000. These charts are updated every three years or as needed to accommodate major changes.

## AIRPORTS

### Landplane

All recognizable runways, including some which may be closed, are shown for visual identification.



Public



Private



Unverified



Abandoned



### Seaplane



### Airport Data Grouping

Boxed airport name indicates airport for which a Special Traffic Rule has been established.

(Pvt): Non-public use having emergency or landmark value.  
 "OBJECTIONABLE": This airport may adversely affect airspace use.

Flight Service Station on field

FSS

Airspace where fixed wing special visual flight rules operations are prohibited (shown above airport name) FAR 91

NO SVFR

Indicates FAR 93 Special Air Traffic Rules and Airport Traffic

NAME

Location Identifier

(NAM)

ICAO Location Identifier

(PNAM)

Control Tower (CT) - primary frequency

CT - 119.1

Star indicates operation part-time. See tower frequencies tabulation for hours of operation

\*

When lighting is lacking, the respective character is replaced by a dash.

Lighting codes refer to runway edge lights and may not represent the longest runway or full length lighting. Dashes are not shown on heliports or helipads unless additional information follows the elevation (e.g. UNICOM, CTAF).

### Heliport

Heliports public and private



Medical Center



Helipads located at major airports (when requested)



### Ultralight Flight Park



FSS  
 NO SVFR  
 NAME (NAM) (PNAM)  
 CT - 119.1 \* (119.8 HELI)  
 ATIS 115.4  
 ASOS/AWOS 135.42  
 285 L 122.95  
 (Unverified)  
 AOE

Automated Terminal Information Service

ATIS 115.4

Automated Surface Weather Observing Systems (shown when full-time ATIS is not available). Some ASOS/AWOS facilities may not be located at airports.

ASOS/AWOS 135.42

Elevation in feet

285

Lighting in operation Sunset to Sunshine

L

Lighting limitations exists, refer to Chart Supplement

L

UNICOM - Aeronautical advisory station

122.95

Follows the Common Traffic Advisory Frequency (CTAF)

C

Unverified Heliport

(Unverified)

Airport of Entry

AOE

# RADIO AIDS TO NAVIGATION

## NAVAIDs

### VHF Omni-Directional Radio (VOR) Range

Open circle symbol shown when NAVAID located on airport. Type of NAVAID shown in top of box.

Compass Rose is "reference" oriented to magnetic north.

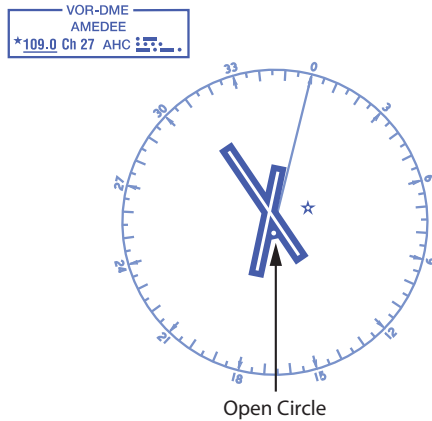

### VOR

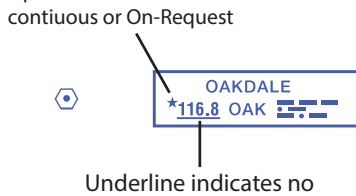

### VORTAC

When an NDB NAVAID shares the same name and Morse Code as the VOR NAVAID the frequency can be collocated inside the same box to conserve space.

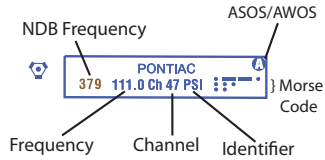

### VOR-DME

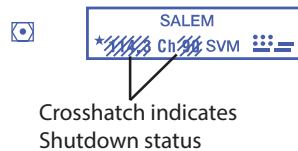

### DME



### Flight Service Station (FSS)

Heavy line box indicates Flight Service Station (FSS) Frequencies 121.5, 122.2, 243.0 and 255.4 (Canada 121.5, 126.7, and 243.0) are available at many FSSs and are not shown above boxes. All other frequencies are shown.

Certain FSSs provide Airport Advisory Service, refer to Chart Supplement.

R - Receive Only



## Non-Directional Radio Beacon (NDB)

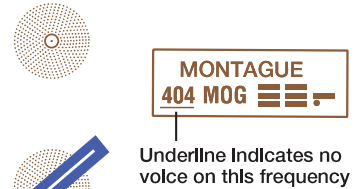

### NDB-DME

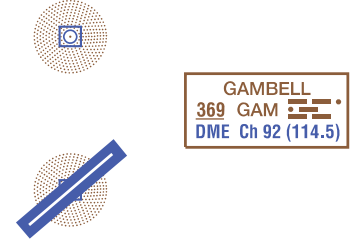

### NAVAID Used to Define Class B Airspace

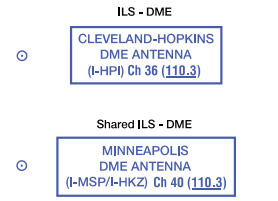

### Broadcast Stations (BS)

On request by the proper authority or when a VFR Checkpoint.



### Remote Communications Outlet (RCO)

Frequencies above thin line box are remotized to NAVAID site. Other FSS frequencies providing voice communications may be available as determined by altitude and terrain. Consult Chart Supplement for complete information.

Thin line box without frequencies and controlling FSS name indicates no FSS frequency available.

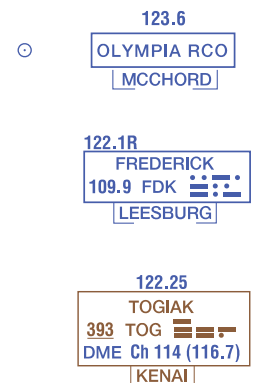

# AIRSPACE INFORMATION

## Class B Airspace

Appropriate notes as required may be shown. (Mode C see FAR 91.215/AIM)

All mileages are nautical (NM)

(Floors extending "upward from above" a certain altitude are preceded by a +. Operations at and below these altitudes are outside of Class B Airspace.)

All radials are magnetic.

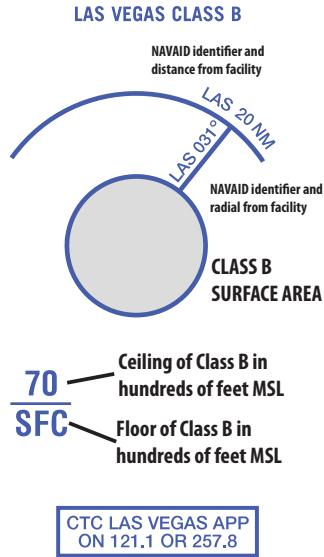

## Class C Airspace

Appropriate notes as required may be shown. (Mode C see FAR 91.215/AIM)

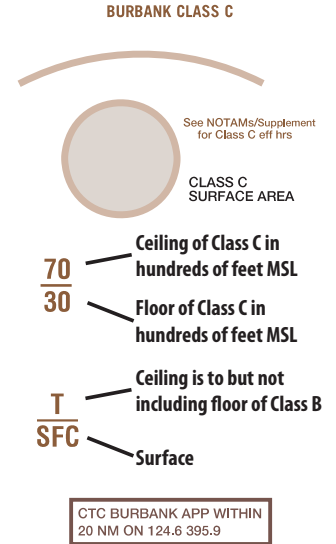

## Class D Airspace

(A minus in front of the figure is used to indicate "from surface to but not including...")

Altitudes in hundreds of feet MSL.

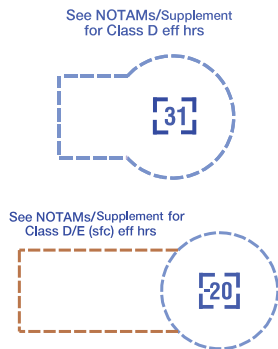

## Class E Surface (SFC) Airspace

See NOTAMs/Supplement for Class E (sfc) eff hrs

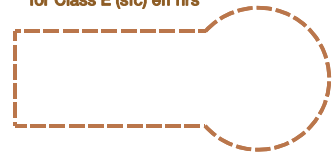

## Special Airspace Areas

### Special Flight Rules Area (SFRA) Relating to National Security

Example: Washington DC

Appropriate notes as required may be shown.

Note: Delimiting line not shown when it coincides with International Boundary, projection lines or other linear features.

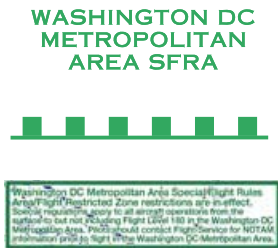

# AIRSPACE INFORMATION (Continued)

Example: Washington DC

## Special Airspace Areas (Continued)

### Flight Restricted Zone (FRZ) Relating to National Security

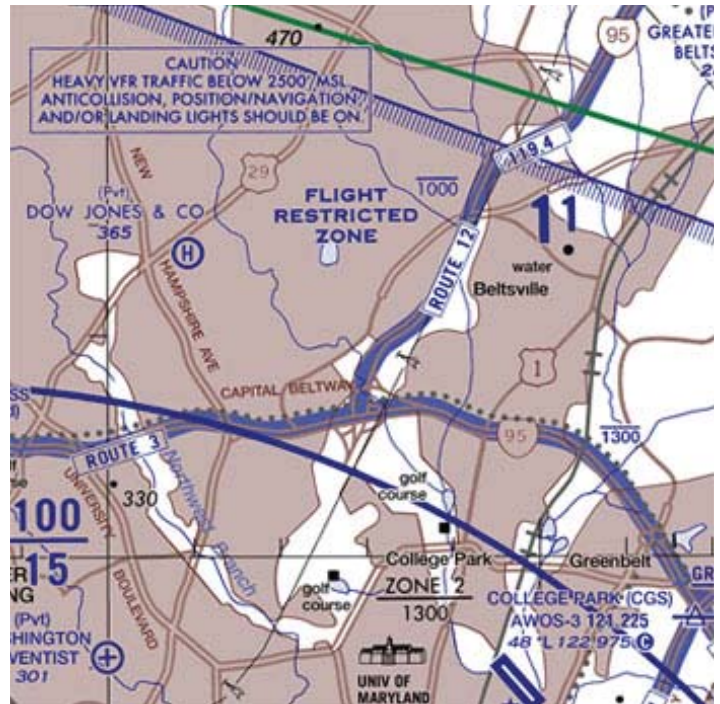

### Air Defense Identification Zone (ADIZ)

Note: Delimiting line not shown when it coincides with International Boundary, projection lines or other linear features.

**CONTIGUOUS U.S. ADIZ**



### Special Security Notice Permanent Continuous Flight Restriction Areas



DISNEYLAND THEME PARK  
See Panel for requirements

### Mode C (FAR 91.215)

Appropriate notes as required may be shown.

MODE C

30 NM

### Terminal Radar Service Area (TRSA)

PALM SPRINGS TRSA

Appropriate notes as required may be shown.



SEE TWR FREQ TAB

**80** - Ceiling of TRSA in hundreds of feet MSL  
**40** - Floor of TRSA in hundreds of feet MSL

### Special Air Traffic Rules / Airport Traffic Areas (FAR Part 93)



Appropriate boxed notes as required shown adjacent to area.

**SPECIAL NOTICE**  
Pilots are required to obtain an ATC clearance prior to entering this area.

### Sporting Event Temporary Flight Restriction (TFR) Sites



### Miscellaneous Activity Areas

Aerobatic Practice Area



Glider Operations



Hang Glider Activity



Ultralight Activity



Unmanned Aircraft Activity



Parachute Jumping Area with Frequency



Space Launch Activity Area



# AIRSPACE INFORMATION (Continued)

## Military Training Routes (MTR)

### Police Zones

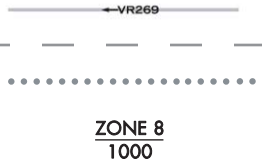

## Helicopter Routes

Primary Route with Route Name and Tower Frequency



Secondary Route



Transition Symbol



## Reporting Points

Non-compulsory



Compulsory



Reporting Point Name

BAHAI

## Canadian Airspace

Class B, C or D TCA

Airspace Ceiling and Floor

80  
40

Class E Control Zone

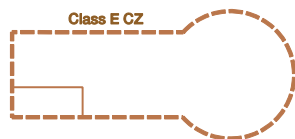

## Special Conservation Areas

National Park, Wildlife Refuge, Primitive and Wilderness Areas, etc.

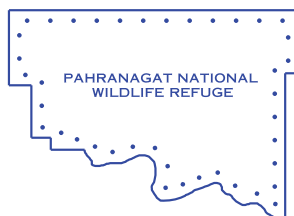

## Special Use Airspace

Only the airspace effective below 18,000 feet MSL is shown.

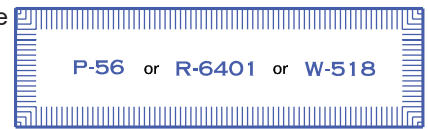

PROHIBITED, RESTRICTED or WARNING AREA

The type of area shall be spelled out in large areas if space permits.

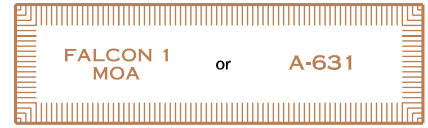

MILITARY OPERATIONS AREA (MOA) or ALERT AREA

One-way Route



Altitude Changeover Point



## Recommended Altitudes

Maximum Altitude

500

Minimum Altitude

500

Recommended Altitude

500

Class B, C or D Control Zone

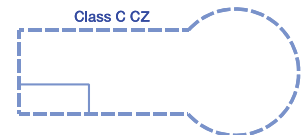

NOAA Regulated National Marine Sanctuary Designated Areas



Flight operations below 1000' AGL over the designated areas within the Gulf of Farallones National Marine Sanctuary violate NOAA regulations (see 15 CFR 922).

# NAVIGATIONAL AND PROCEDURAL INFORMATION

## VFR Checkpoints

Underline indicates proper name of VFR Checkpoint.

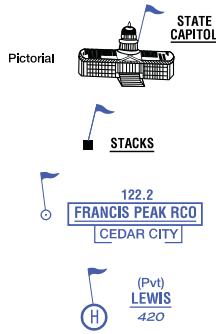

## Obstruction

Above 299' and below 1000' AGL



1000' and higher AGL



## High-Intensity Obstruction Lights

High-intensity lights may operate part-time or by proximity activation.

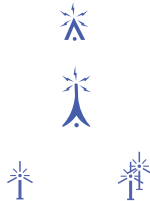

## Navigation Data

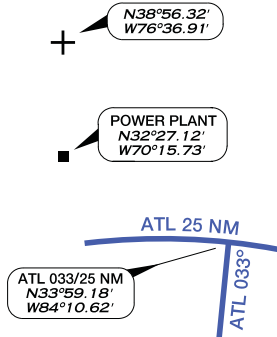

## VFR Waypoints

Stand-Alone



Collocated with VFR Checkpoint



Collocated with VFR Checkpoint & Reporting Point



## Group Obstruction

Above 299' and below 1000' AGL



1000' and higher AGL



## Wind Turbine Farms

When highest wind turbine is unverified, UC will be shown after MSL value.

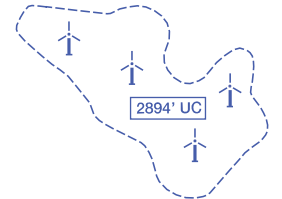

## Maximum Elevation Figure (MEF)

(see VFR Terms tab for explanation)

**124**

# CULTURE

## Railroads

Single Track 

Double Track 

## Bridges

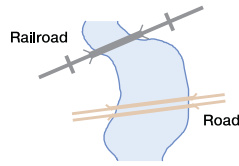

## Populated Places

Built-up Areas 

## Roads

Dual-Lane:  
Divided Highways 

Major Boulevards & Major Streets  
Primary 

## Boundaries

International 

State or Province 







## Power Transmission Lines



## Prominent Pictorials



## Landmarks

-  Landmark-stadium, factory, school, etc.
-  Lookout Tower
-  Mines or Quarries
-  Race Track
-  Outdoor Theater
-  Tank-water, oil or gas





# AIRSPACE

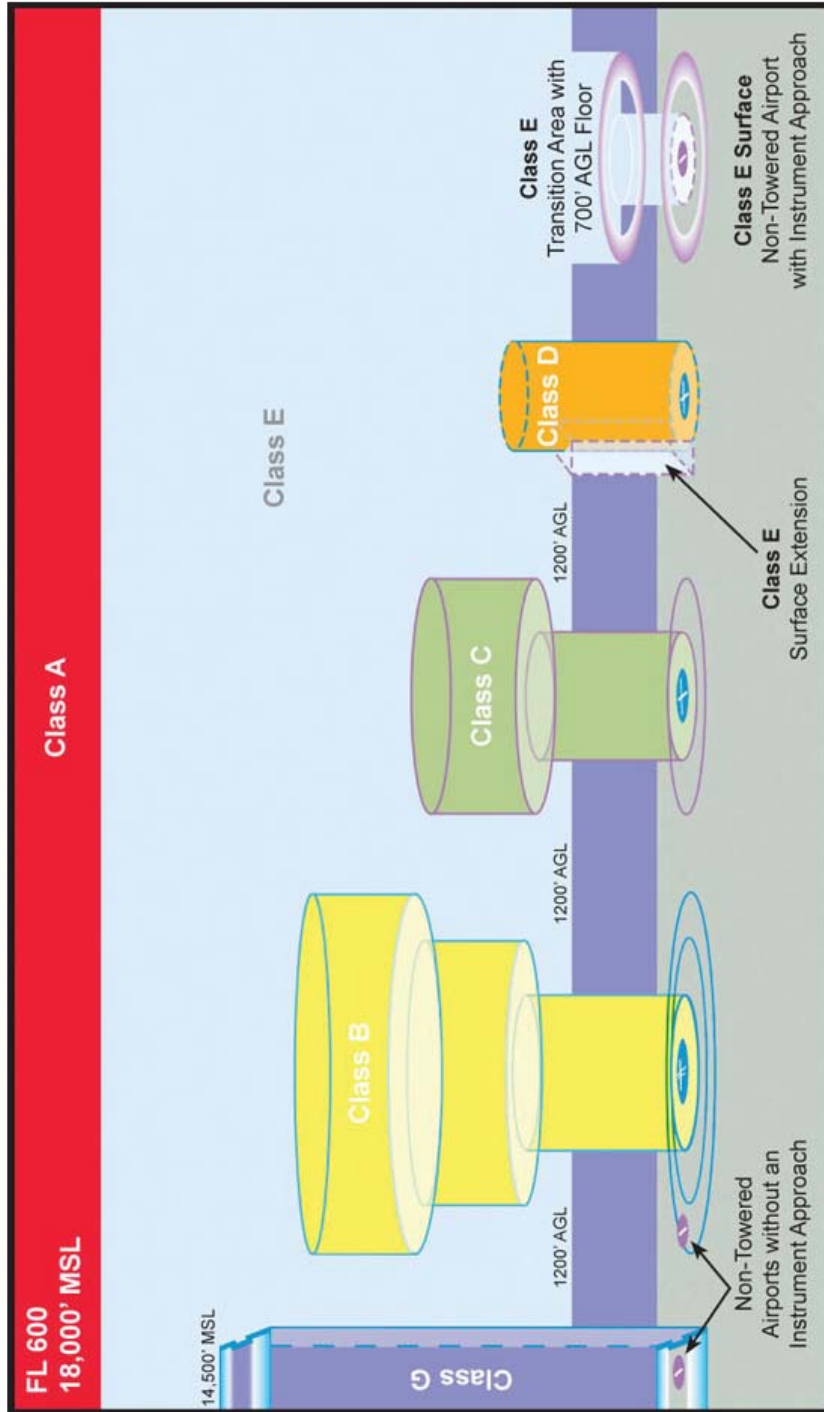

U.S. Airspace depiction as shown on Visual Aeronautical Charts

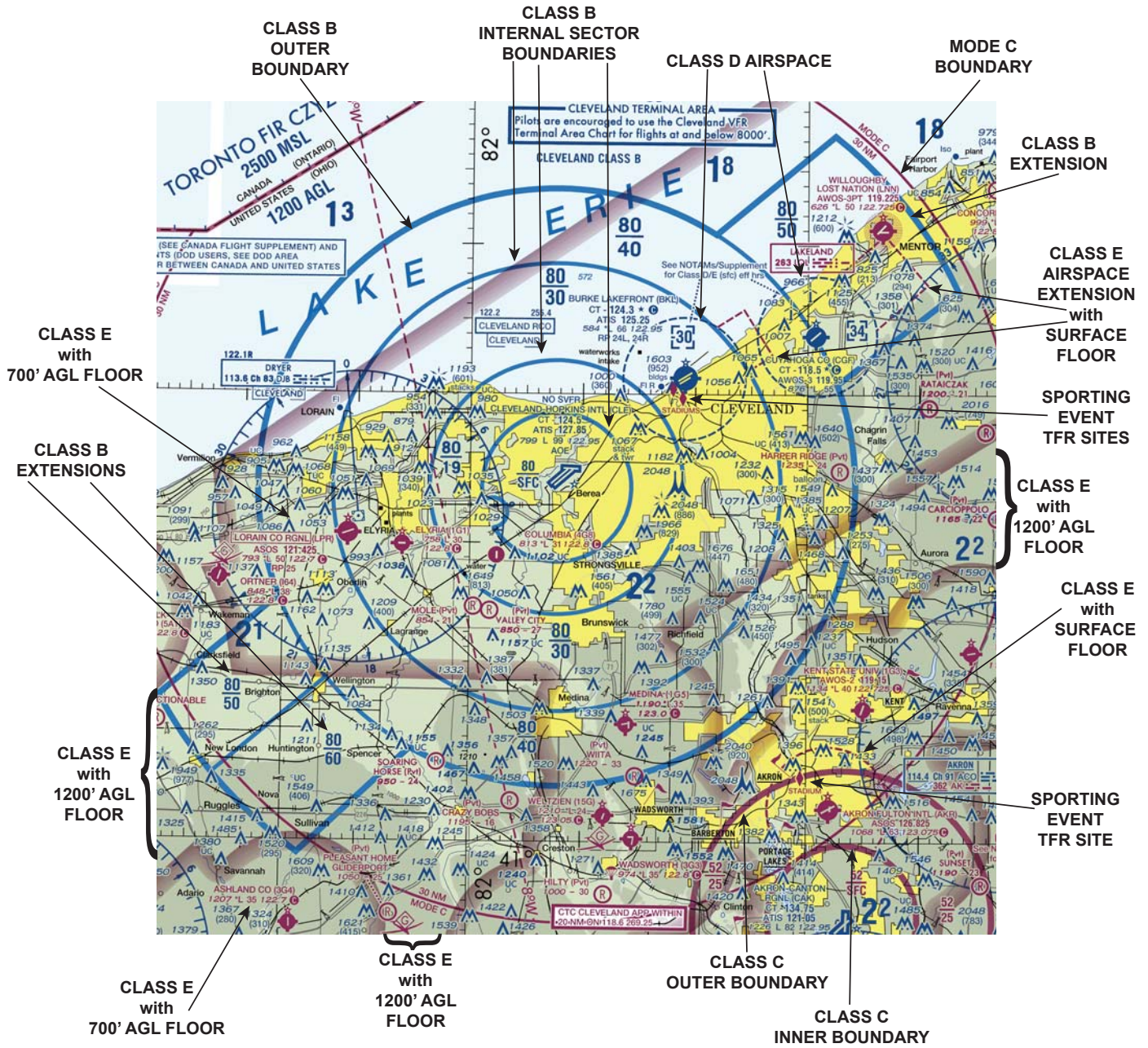

Excerpt from Detroit Sectional Chart

# EXPLANATION OF IFR ENROUTE TERMS

FAA charts are prepared in accordance with specifications of the Interagency Air Committee (IAC), and are approved by representatives of the Federal Aviation Administration and the Department of Defense (DoD). Some information on these charts may only apply to military pilots.

The explanations of symbols used on Instrument Flight Rule (IFR) Enroute Charts and examples in this section are based primarily on the IFR Enroute Low Altitude Charts. Other IFR products use similar symbols in various colors. The chart legends portray aeronautical symbols with a brief description of what each symbol depicts. This section provides more details of the symbols and how they are used on IFR Enroute charts.

## AIRPORTS

Active airports are shown on IFR Enroute Charts.

Low Charts:

- All IAP Airports are shown on the Low Altitude Charts (US and Alaska).
- Non-IAP Airports are shown on the U.S. Low Altitude Charts (Contiguous US) have a minimum hard surface runway of 3,000'.
- Non-IAP airports are shown on the U.S. Low Altitude Alaska Charts are show if the runway is 3000' or longer, hard or soft surface.
- Public heliports with an Instrument Approach Procedure (IAP) or requested by the FAA or DoD are depicted on the IFR Enroute Low Altitude Charts.
- Seaplane bases requested by the FAA or DoD are depicted on the IFR Enroute Low Altitude Charts.

On IFR Enroute Low Altitude Charts, airport tabulation is provided which identifies airport names, IDs and the panels they are located on.

High Charts:

- Airports shown on the U.S. High Enroute Charts (Contiguous US) have a minimum hard surface runway of 5000'.
- Airports shown on the U.S. High Enroute Alaska Charts have a minimum hard surface runway of 4000'.

Charted airports are classified according to the following criteria:

### LOW/HIGH ALTITUDE



**Blue** - Airports with an Instrument Approach Procedure and/or RADAR MINIMA published in the high altitude DoD Flight Information Publications (FLIPs)

**Green** - Airports which have an approved Instrument Approach Procedure and/or RADAR MINIMA published in either the U.S. Terminal Procedures Publications (TPPs) or the DoD FLIPs

**Brown** - Airports without a published Instrument Approach Procedure or RADAR MINIMA

Airports are plotted at their true geographic position.

Airports are identified by the airport name. In the case of military airports, Air Force Base (AFB), Naval Air Station (NAS), Naval Air Facility (NAF), Marine Corps Air Station (MCAS), Army Air Field (AAF), etc., the abbreviated letters appear as part of the airport name.



# RADIO AIDS TO NAVIGATION

All IFR radio NAVAIDs that have been flight checked and are operational are shown on all IFR Enroute Charts. Very High Frequency/Ultrahigh Frequency (VHF/UHF) NAVAIDs, Very high frequency Omnidirectional Radio range (VORs), Tactical Air Navigation (TACANs) are shown in black, and Low Frequency/Medium Frequency (LF/MF) NAVAIDs, (Compass Locators and Aeronautical or Marine NDBs) are shown in brown.

On IFR Enroute Charts, information about NAVAIDs is boxed as illustrated below. To avoid duplication of data, when two or more NAVAIDs in a general area have the same name, the name is usually printed only once inside an identification box with the frequencies, TACAN channel numbers, identification letters, or Morse Code Identifications of the different NAVAIDs are shown in appropriate colors.

NAVAIDs in a shutdown status have the frequency and channel number crosshatched. Use of the NAVAID status "shut-down" is only used when a facility has been decommissioned but cannot be published as such because of pending airspace actions.

NAVIGATION AND COMMUNICATION BOXES - COMMON ELEMENTS							
<p><b>LOW ENROUTE CHARTS</b></p> <p>RCO Frequencies NAVAID Name FREQ, Ident, CH, Morse Code Latitude, Longitude Controlling FSS Name</p> <div style="border: 1px solid black; padding: 5px; width: fit-content; margin: 10px auto;"> <p style="text-align: center;">000.0 NAME 000.0 IDT 000  N00°00.00' W000°00.00' [NAME]</p> </div>	<p><b>HIGH ENROUTE CHARTS</b></p> <p>RCO Frequencies NAVAID Name Frequency, Ident, Channel, Latitude, Longitude Controlling FSS Name</p> <div style="border: 1px solid black; padding: 5px; width: fit-content; margin: 10px auto;"> <p style="text-align: center;">000.0 NAME 000.0 IDT 000 N00°00.00' W000°00.00' [NAME]</p> </div>						
<b>COMMON ELEMENTS (HIGH AND LOW CHARTS)</b>							
<p><b>RCO FREQUENCY</b> Single Frequency</p> <p>Multiple Frequencies Frequencies transmit and receive except those followed by R and T: R - Receive Only      T - Transmit Only</p>	<p>122.6</p> <p>255.4 243.0 123.6 122.65 122.2 122.1R 121.5</p>						
<p><b>NAVAID BOX</b></p> <p>Thin line NAVAID boxes without frequency(s) and FSS radio name indicates no FSS frequencies available.</p> <p>Shadow NAVAID box indicates NAVAID and Flight Service Station (FSS) have same name.</p>	<table border="0" style="width: 100%;"> <tr> <td style="width: 50%; text-align: center;">VHF/UHF</td> <td style="width: 50%; text-align: center;">LF/MF</td> </tr> <tr> <td style="text-align: center;"></td> <td style="text-align: center;"></td> </tr> <tr> <td style="text-align: center;"></td> <td style="text-align: center;"></td> </tr> </table>	VHF/UHF	LF/MF				
VHF/UHF	LF/MF						
<p><b>FREQUENCY PROTECTION</b></p> <p>Frequency Protection usable range at 18,000' AGL - 40 NM</p> <p>Frequency Protection usable range at 12,000' AGL - 25 NM</p>	<p>(L)</p> <p>(T)</p>						
<p><b>DISTANCE MEASURING EQUIPMENT</b></p> <p>Facilities that operate in the "Y" mode for DME reception</p>	<p>(Y)</p>						
<p><b>VOICE COMMUNICATIONS VIA NAVAID</b></p> <p>Voice Transmitted</p> <p>No Voice Transmitted</p>	<p>112.6</p> <p><u>111.0</u></p>						
<p><b>NAVAID SHUTDOWN STATUS</b></p>	<table border="0" style="width: 100%;"> <tr> <td style="width: 50%; text-align: center;">VHF/UHF</td> <td style="width: 50%; text-align: center;">LF/MF</td> </tr> <tr> <td style="text-align: center;"></td> <td style="text-align: center;"></td> </tr> </table>	VHF/UHF	LF/MF				
VHF/UHF	LF/MF						
<p><b>PART TIME OR ON-REQUEST</b></p>	<table border="0" style="width: 100%;"> <tr> <td style="width: 50%; text-align: center;">VHF/UHF</td> <td style="width: 50%; text-align: center;">LF/MF</td> </tr> <tr> <td style="text-align: center;">★</td> <td style="text-align: center;">★</td> </tr> </table>	VHF/UHF	LF/MF	★	★		
VHF/UHF	LF/MF						
★	★						

<b>AUTOMATED WEATHER BROADCAST SERVICES</b> <b>ASOS/AWOS</b> - Automated Surface Observing Station/Automated Weather Observing Station	<div style="text-align: center;"> VHF/UHF      LF/MF         </div> <p style="text-align: center;"><i>Automated weather, when available, is broadcast on the associated NAVAID frequency.</i></p>
<b>LATITUDE AND LONGITUDE</b>  <i>Latitude and Longitude coordinates are provided for those NAVAIDs that make up part of a route/airway or a holding pattern. All TACAN facilities will include geographic coordinates.</i>	<div style="display: flex; justify-content: space-around;"> <div style="text-align: center;"> <b>LOW ENROUTE</b>  </div> <div style="text-align: center;"> <b>HIGH ENROUTE</b>  </div> </div>

## AIRSPACE INFORMATION

### CONTROLLED AIRSPACE

Controlled airspace consists of those areas where some or all aircraft are subjected to air traffic control within the following airspace classifications of A, B, C, D, & E.

Air Route Traffic Control Centers (ARTCC) are established to provide Air Traffic Control to aircraft operating on IFR flight plans within controlled airspace, particularly during the enroute phase of flight. Boundaries of the ARTCCs are shown in their entirety using the symbol below.



When Controller Pilot Data Link Communication (CPDLC) exists for an ARTCC, the text CPDLC (LOGON KUSA) will be shown parallel to the boundary above or below the ARTCC identification as shown below.

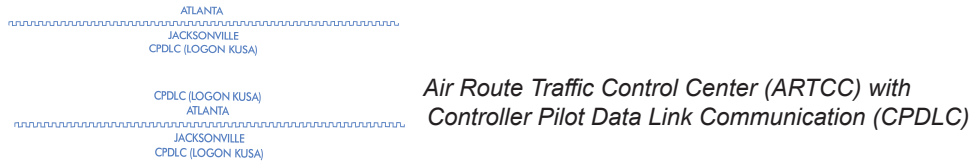

The responsible ARTCC Center names are shown adjacent and parallel to the boundary line. ARTCC sector frequencies are shown in boxes outlined by the same symbol.

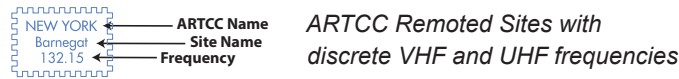

**Class A** Airspace is depicted as open area (white) on the IFR Enroute High Altitude Charts. It consists of airspace from 18,000 Mean Sea Level (MSL) to FL600.

**Class B** Airspace is depicted as screened blue area with a solid line encompassing the area.

**Class C** Airspace is depicted as screened blue area with a dashed line encompassing the area with a letter “C” enclosed in a box following the airport name.

Class B and Class C Airspace consist of controlled airspace extending upward from the surface or a designated floor to specified altitudes, within which all aircraft and pilots are subject to the operating rules and requirements specified in the Federal Aviation Regulations (UHF) 71. Class B and C Airspace are shown in abbreviated forms on IFR Enroute Low Altitude Charts. A general note adjacent to Class B airspace refers the user to the appropriate VFR Terminal Area Chart.

**Class D** Airspace (airports with an operating control tower) are depicted as open area (white) with a letter “D” enclosed in a box following the airport name.

**Class E** Airspace is depicted as open area (white) on the IFR Enroute Low Altitude Charts. It consists of airspace below FL180.

## UNCONTROLLED AIRSPACE

**Class G** Airspace within the United States extends to 14,500' MSL. This uncontrolled airspace is shown as screened brown.

## SPECIAL USE AIRSPACE

Special Use Airspace (SUA) confines certain flight activities, restricts entry, or cautions other aircraft operating within specific boundaries. SUA areas are shown in their entirety, even when they overlap, adjoin, or when an area is designated within another area. SUA with altitudes from the surface and above are shown on the IFR Enroute Low Altitude Charts. Similarly, SUA that extends above 18,000' MSL are shown on IFR Enroute High Altitude Charts. IFR Enroute Charts tabulations identify the type of SUA, ID, effective altitudes, times of use, controlling agency and the panel it is located on. Users need to be aware that a NOTAM addressing activation will NOT be issued to announce permanently listed times of use.

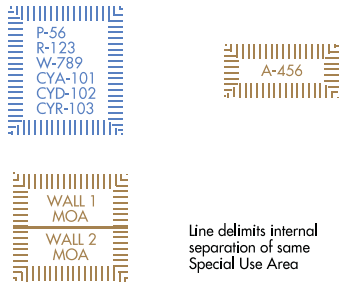

High and Low	Low Altitude Only	Canada Only	Caribbean Only
P - Prohibited Area	MOA - Military Operations Area	CYA - Advisory	D - Danger
R - Restricted Area	A - Alert Area *	CYD - Danger Area	
W - Warning Area		CYR - Restricted Area	
* Alert Areas do not extend into Class A, B, C and D airspace, or Class E airport surface areas.			
See Airspace Tabulation on chart for complete information.			

## OTHER AIRSPACE

**FAR 91 Special Air Traffic Rules** are shown with the type NO SVFR above the airport name.

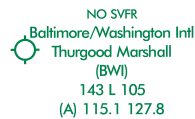

**FAR 93 Special Airspace Traffic Rules** are shown with a solid line box around the airport name, indicating FAR 93 Special Requirements see Chart Supplement.

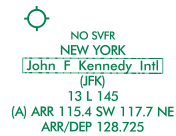

**Mode C Required Airspace** (from the surface to 10,000' MSL) within 30 NM radius of the primary airport(s) for which a Class B airspace is designated, is depicted on IFR Enroute Low Altitude Charts as a blue circle labeled MODE C 30 NM.



Mode C is also required for operations within and above all Class C airspace up to 10,000' MSL, but not depicted. See FAR 91.215 and the AIM.

## INSTRUMENT AIRWAYS

The FAA has established two fixed route systems for air navigation. The VOR and LF/MF system-designated from 1,200' Above Ground Level (AGL) to but not including FL 180 is shown on IFR Enroute Low Altitude Charts, and the Jet Route system designated from FL 180 to FL 450 inclusive is shown on IFR Enroute High Altitude Charts.

### VOR LF/MF AIRWAY SYSTEM (IFR LOW ALTITUDE ENROUTE CHARTS)

In this system VOR airways - airways based on VOR or VORTAC NAVAIDs - are depicted in black and identified by a "V" (Victor) followed by the route number (e.g., "V12").

LF/MF airways - airways based on LF/MF NAVAIDs - are sometimes called "colored airways" because they are identified by color name and number (e.g., "Amber One", charted as "A1"). In Alaska Green and Red airways are plotted east and west, and Amber and Blue airways are plotted north and south. Regardless of their color identifier, LF/MF airways are shown in brown.

### AIRWAY/ROUTE DATA

On both series of IFR Enroute Charts, airway/route data such as the airway identifications, magnetic courses bearings or radials, mileages, and altitudes (e.g., Minimum Enroute Altitudes (MEAs), Minimum Reception Altitudes (MRAs), Maximum Authorized Altitudes (MAAs), Minimum Obstacle Clearance Altitudes (MOCAs), Minimum Turning Altitudes (MTAs) and Minimum Crossing Altitudes (MCAs)) are shown aligned with the airway.

As a rule the airway/route data is charted and in the same color as the airway, with one exception. Charted in blue, Global Navigation Satellite System (GNSS) MEAs, identified with a "G" suffix, have been added to "V" and "colored airways" for aircraft flying those airways using Global Positioning System (GPS) navigation.

Airways/Routes predicated on VOR or VORTAC NAVAIDs are defined by the outbound radial from the NAVAID. Airways/Routes predicated on LF/MF NAVAIDs are defined by the inbound bearing.

- **Minimum Enroute Altitude (MEA)** - The MEA is the lowest published altitude between radio fixes that assures acceptable navigational signal coverage and meets obstacle clearance requirements between those fixes. The MEA prescribed for a Federal airway or segment, RNAV low or high route, or other direct route applies to the entire width of the airway, segment, or route between the radio fixes defining the airway, segment, or route. MEAs for routes wholly contained within controlled airspace normally provide a buffer above the floor of controlled airspace consisting of at least 300 feet within transition areas and 500 feet within control areas. MEAs are established based upon obstacle clearance over terrain and man-made objects, adequacy of navigation facility performance, and communications requirements.
- **Minimum Reception Altitude (MRA)** - MRAs are determined by FAA flight inspection traversing an entire route of flight to establish the minimum altitude the navigation signal can be received for the route and for off-course NAVAID facilities that determine a fix. When the MRA at the fix is higher than the MEA, an MRA is established for the fix and is the lowest altitude at which an intersection can be determined.
- **Maximum Authorized Altitude (MAA)** - An MAA is a published altitude representing the maximum usable altitude or flight level for an airspace structure or route segment. It is the highest altitude on a Federal airway, jet route, RNAV low or high route, or other direct route for which an MEA is designated at which adequate reception of navigation signals is assured.
- **Minimum Obstruction Clearance Altitude (MOCA)** - The MOCA is the lowest published altitude in effect between fixes on VOR airways, off-airway routes, or route segments that meets obstacle clearance requirements for a VOR. The MOCA seen on the enroute chart may have been computed by adding the required obstacle clearance (ROC) to the controlling obstacle in the primary area or computed by using a TERPS chart if the controlling obstacle is located in the secondary area. This figure is then rounded to the nearest 100 foot increment (i.e., 2,049 feet becomes 2,000, and 2,050 feet becomes 2,100 feet). An extra 1,000 feet is added in mountainous areas, in most cases.



- Minimum Turning Altitude (MTA)** - Minimum turning altitude (MTA) is a charted altitude providing vertical and lateral obstruction clearance based on turn criteria over certain fixes, NAVAIDs, waypoints, and on charted route segments. When a VHF airway or route terminates at a NAVAID or fix, the primary area extends beyond that termination point. When a change of course on VHF airways and routes is necessary, the enroute obstacle clearance turning area extends the primary and secondary obstacle clearance areas to accommodate the turn radius of the aircraft. Since turns at or after fix passage may exceed airway and route boundaries, pilots are expected to adhere to airway and route protected airspace by leading turns early before a fix. The turn area provides obstacle clearance for both turn anticipation (turning prior to the fix) and flyover protection (turning after crossing the fix). Turning fixes requiring a higher MTA are charted with a flag along with accompanying text describing the MTA restriction.
- Minimum Crossing Altitude (MCA)** - An MCA is the lowest altitude at certain fixes at which the aircraft must cross when proceeding in the direction of a higher minimum enroute IFR altitude. MCAs are established in all cases where obstacles intervene to prevent pilots from maintaining obstacle clearance during a normal climb to a higher MEA after passing a point beyond which the higher MEA applies. The same protected enroute area vertical obstacle clearance requirements for the primary and secondary areas are considered in the determination of the MCA.



Victor Route (with RNAV/GPS MEA shown in blue)

## AREA NAVIGATION (RNAV) "T" ROUTE SYSTEM

The FAA has created new low altitude area navigation (RNAV) "T" routes for the enroute and terminal environments. The RNAV routes will provide more direct routing for IFR aircraft and enhance the safety and efficiency of the National Air-space System. To utilize these routes aircraft are required to be equipped with IFR approved GNSS. In Alaska, TSO-145a and 146a equipment is required.

Low altitude RNAV only routes are identified by the prefix "T", and the prefix "TK" for RNAV helicopter routes followed by a three digit number (T-200 to T-500). Routes are depicted in blue on the IFR Enroute Low Altitude Charts. RNAV route data (route line, identification boxes, mileages, waypoints, waypoint names, magnetic reference courses and MEAs) will also be printed in blue. Magnetic reference courses will be shown originating from a waypoint, fix/reporting point or NAVAID. GNSS MEA for each segment is established to ensure obstacle clearance and communications reception. GNSS MEAs are identified with a "G" suffix.

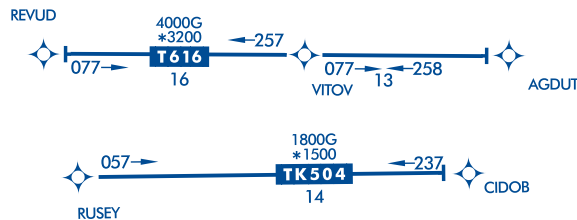

Joint Victor/RNAV routes are charted as outlined above except as noted. The joint Victor route and the RNAV route identification boxes are shown adjacent to each other. Magnetic reference courses are not shown. MEAs are charted above the appropriate identification box or stacked in pairs, GNSS and Victor. On joint routes, RNAV specific information will be printed in blue.

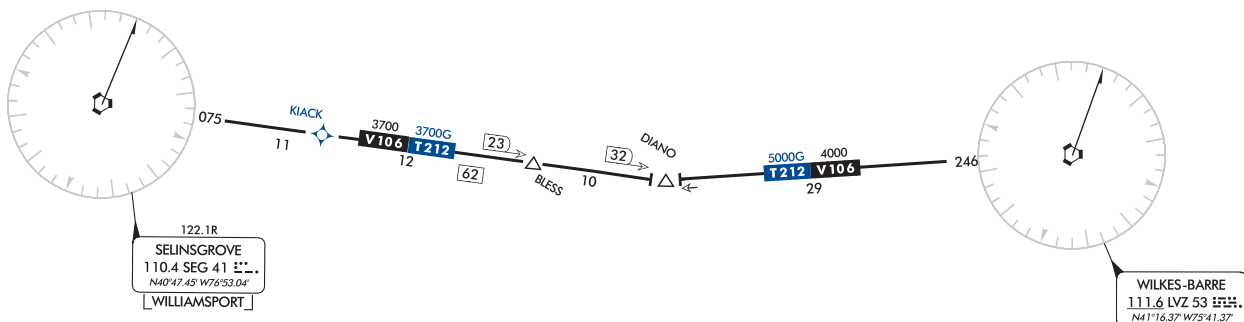

## UNUSABLE AIRWAY/ROUTE SEGMENTS

Airway/Route segments designated by the FAA as unusable will be depicted as shown below.

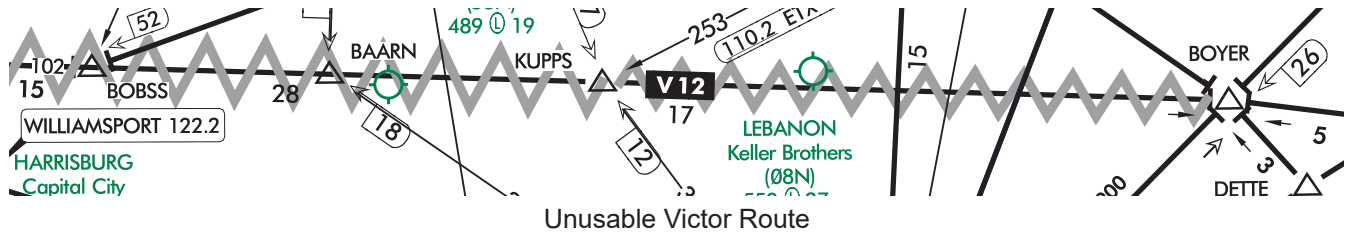

Pilots should not file a flight plan for or accept a clearance that includes navigation on any route or route segment depicted as unusable. Pilots using RNAV may request ATC clearance to fly point-to-point between valid waypoints or fixes, even those on routes depicted as unusable (refer to AC 90-108 for RNAV eligibility).

## Coincident Airways/Routes with Unusable Segment

When two airways/routes are coincident, but only one airway/route is designated as unusable, the following note indicating which airway the unusable symbology applies to will be placed in close proximity to the airway/route identifiers.



## OFF ROUTE OBSTRUCTION CLEARANCE ALTITUDE (OROCA)

The Off Route Obstruction Clearance Altitude (OROCA) is depicted on IFR Enroute Low Altitude and Pacific charts and is represented in thousands and hundreds of feet above MSL. OROCA's are shown in every 30 x 30 minute quadrant on Area Charts, every one degree by one degree quadrant for IFR Enroute Low Altitude Charts - U.S. and every two degree by two degree quadrant on IFR Enroute Low Altitude Charts - Alaska. The OROCA represents the highest possible obstruction elevation including both terrain and other vertical obstruction data (towers, trees, etc.) bounded by the ticked lines of latitude/longitude including data 4 NM outside the quadrant. In this example the OROCA represents 12,500 feet.

OROCA is computed just as the Maximum Elevation Figure (MEF) found on Visual Flight Rule (VFR) Charts except that it provides an additional vertical buffer of 1,000 feet in designated non-mountainous areas and a 2,000 foot vertical buffer in designated mountainous areas within the United States. For areas in Mexico and the Caribbean, located outside the U.S. Air Defense Identification Zone (ADIZ), the OROCA provides obstruction clearance with a 3,000 foot vertical buffer. Evaluating the area around the quadrant provides the chart user the same lateral clearance an airway provides should the line of intended flight follow a ticked line of latitude or longitude. OROCA does not provide for NAVAID signal coverage, communication coverage and would not be consistent with altitudes assigned by Air Traffic Control. OROCA's can be found over all land masses and open water areas containing man-made obstructions (such as oil rigs).

12<sup>5</sup>

## MILITARY TRAINING ROUTES (MTRs)

Military Training Routes (MTRs) are routes established for the conduct of low-altitude, high-speed military flight training (generally below 10,000 feet MSL at airspeeds in excess of 250 knots Indicated Air Speed). These routes are depicted in brown on IFR Enroute Low Altitude Charts, and are not shown on inset charts or on IFR Enroute High Altitude Charts. IFR Enroute Low Altitude Charts depict all IFR Military Training Routes (IRs) and VFR Military Training Routes (VRs), except those VRs that are entirely at or below 1,500 feet AGL.

MTRs are identified by designators (IR-107, VR-134) which are shown in brown on the route centerline. Arrows are shown to indicate the direction of flight along the route. The width of the route determines the width of the line that is plotted on the chart:

Route segments with a width of 5 NM or less, both sides of the centerline, are shown by a .02" line.



Route segments with a width greater than 5 NM, either or both sides of the centerline, are shown by a .035" line.



MTRs for particular chart pairs (ex. L1/2, etc.) are alphabetically, then numerically tabulated. The tabulation includes MTR type and unique identification and altitude range.

### JET ROUTE SYSTEM (HIGH ALTITUDE ENROUTE CHARTS)

Jet routes are based on VOR or VORTAC NAVAIDs, and are depicted in black with a "J" identifier followed by the route number (e.g., "J12"). In Alaska, Russia and Canada some segments of jet routes are based on LF/MF NAVAIDs.

### AREA NAVIGATION (RNAV) "Q" ROUTE SYSTEM (IFR ENROUTE HIGH ALTITUDE CHARTS)

The FAA has adopted certain amendments to Title 14, Code of Federal Regulations which paved the way for the development of new area high altitude navigation (RNAV) "Q" routes in the U.S. National Airspace System (NAS). These amendments enable the FAA to take advantage of technological advancements in navigation systems such as the GPS. RNAV "Q" Route MEAs are shown when other than FL 180 MEAs for DME/DME/Inertial Reference Unit (IRU) RNAV aircraft have a "D" suffix.

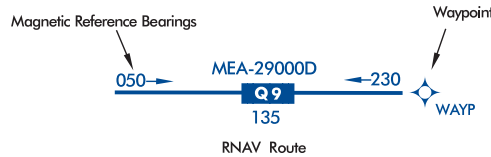

RNAV routes and associated data are charted in blue. "Q" Routes on the IFR Gulf of Mexico charts are shown in black. Magnetic reference courses are shown originating from a waypoint, fix/reporting point, or NAVAID.

Joint Jet/RNAV route identification boxes will be located adjacent to each other with the route charted in black. With the exception of Q-Routes in the Gulf of Mexico, GNSS or DME/DME/IRU RNAV are required, unless otherwise indicated. DME/DME/IRU RNAV aircraft should refer to the Chart Supplement for DME information. Q-Routes in Alaska are GNSS Only. Altitude values are stacked highest to lowest.



### TERRAIN CONTOURS ON AREA CHARTS

Based on a recommendation of the National Transportation Safety Board, terrain contours have been added to the Enroute Area Charts and are intended to increase pilots' situational awareness for safe flight over changes in terrain. The following Area Charts portray terrain: Anchorage, Denver, Fairbanks, Juneau, Los Angeles, Nome, Phoenix, San Francisco, Vancouver and Washington.

When terrain rises at least a 1,000 feet above the primary airports' elevation, terrain is charted using shades of brown with brown contour lines and values. The initial contour will be 1,000 or 2,000 feet above the airports' elevation. Subsequent intervals will be 2,000 or 3,000 foot increments.

Contours are supplemented with a representative number of spots elevations and are shown in solid black. The highest elevation on an Area Chart is shown with a larger spot and text.

The following boxed note is added to the affected Area Charts.

NOTE: TERRAIN CONTOURS HAVE BEEN ADDED TO THOSE AREA CHARTS WHERE THE TERRAIN ON THE CHART IS 1000 FOOT OR GREATER THAN THE ELEVATION OF THE PRIMARY AIRPORT



# IFR ENROUTE LOW / HIGH ALTITUDE SYMBOLS (U.S., PACIFIC AND ALASKA CHARTS)

## AIRPORTS

### Airport Data - Low/High Altitude

Civil

Charts: High/Low



Seaplane - Civil

Charts: Low



Civil And Military

Charts: High/Low



Helicopter

Charts: Low



Military

Charts: High/Low



Emergency Use Only

Pacific Only



Facilities in BLUE or GREEN have an approved Instrument Approach Procedure and/or RADAR MINIMA published in either the FAA Terminal Procedures Publication or the DoD FLIPs. Those in BLUE have an Instrument Approach Procedure and/or RADAR MINIMA published at least in the High Altitude DoD FLIPs. Facilities in BROWN do not have a published Instrument Procedure or RADAR MINIMA.

All IAP Airports are shown on the Low Altitude Charts.

Non-IAP Airports shown on the U.S. Low Altitude Charts have a minimum hard surface runway of 3000'.

Airports shown on the U.S. High Altitude Charts have a minimum hard surface runway of 5000'.

Airports shown on the Alask High Altitude Charts have a minimum hard or soft surface runway of 4000'.

Associated city names for public airports are shown above or preceding the airport name and city name are the same only the airport name is shown. City names for military and private airports are not shown.

The airport identifier in parentheses follows the airport name or Pvt.

Pvt - Private Use

## AIRPORT DATA DEPICTION

### Low Altitude

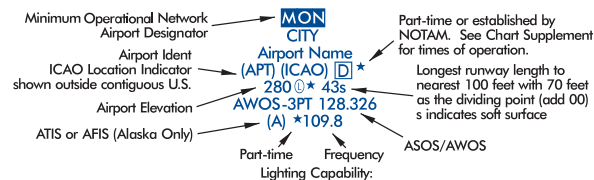

1. Airport elevation given in feet above or below mean sea level

2. Pvt - Private use, not available to general public

3. A solid line box enclosed the airport name indicates FAR 93 Special Requirements - see Directory/Supplement

4. "NO SVFR" above the airport name indicates FAR 91 fixed-wing special VFR flight is prohibited.

5. [C] or [D] following the airport identifier indicates Class C or Class D Airspace

### High Altitude - U.S.



6. Associated city names for public airports are shown above or preceding the airport name. If airport name and city name are the same, only the airport name is shown. The airport identifier in parentheses follows the airport name. City names for military and private airports are not shown.

7. Airport Ident ICAO Location Indicator shown outside contiguous U.S.

8. AFIS Alaska only

### High Altitude - Alaska

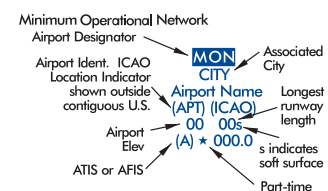

# Airports (Continued)

## LIGHTING CAPABILITY

Lighting Available	L	Part-time or on request	★
Pilot Controlled Lighting	Ⓛ	No lighting available At private facilities- indicates no lighting information is available	-

## RADIO AIDS TO NAVIGATION

### NAVAIDS

VOR	VOR/DME	TACAN	DME	NDB	NDB/DME	Reporting Function
						Non Compulsory Reporting or Off Airway
						Compulsory Reporting

Note: VHF/UHF is depicted in Black. LF/MF is depicted in Brown. RNAV is depicted in Blue

### Compass Roses

#### VHF/UHF

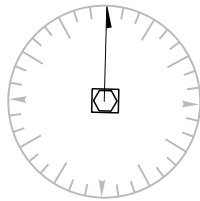

#### LF/MF

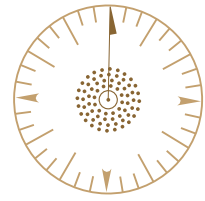

Compass Roses are orientated to Magnetic North of the NAVAID which may not be adjusted to the charted isogonic values.

### Compass Locator Beacon

#### LOW ALTITUDE



#### Chart Example : Enroute Low L-27 US

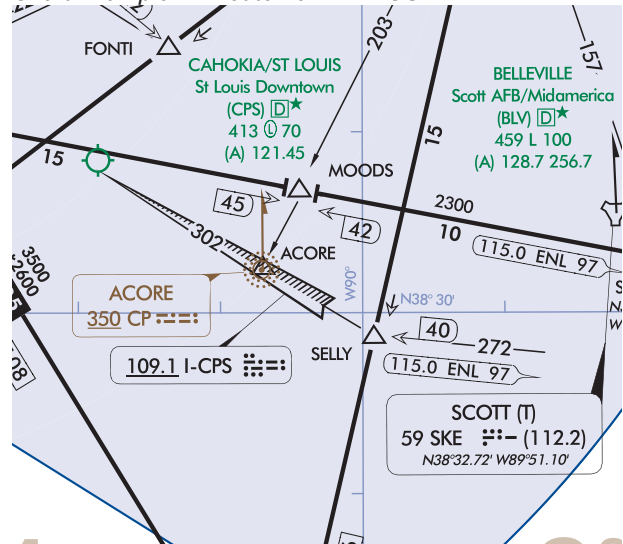

# RADIO AIDS TO NAVIGATION (Continued)

## ILS LOCALIZER

ILS Localizer Course with additional navigation function



ILS Localizer Back Course with additional navigation function



ILS Localizer Example with Back Course  
(Chart: Enroute Low L-1 US)

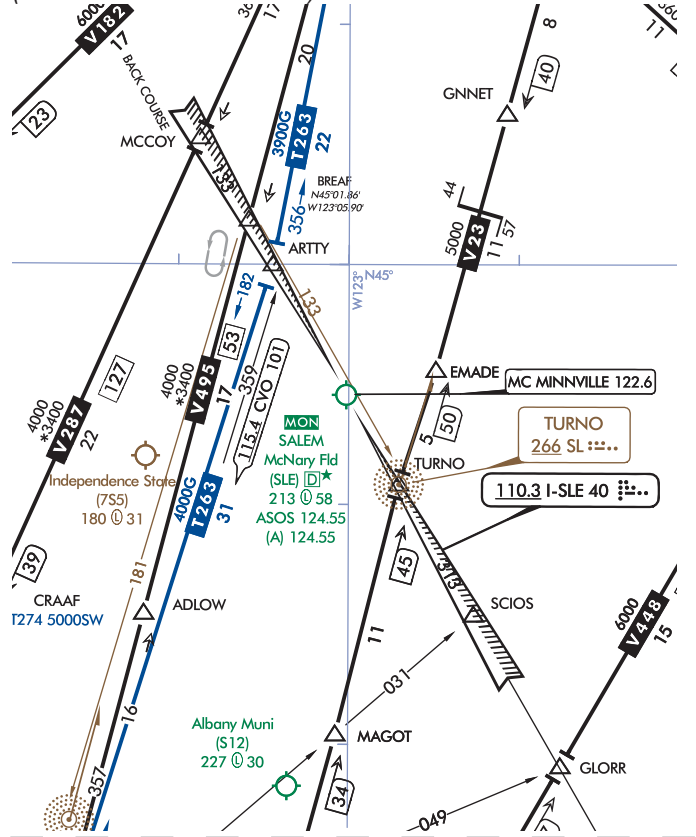

## HIGH ALTITUDE - ALASKA

### VOR/DME RNAV WAYPOINT DATA

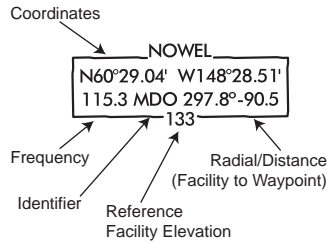

## NAVIGATION AND COMMUNICATION BOXES - COMMON ELEMENTS

### LOW ENROUTE CHARTS

RCO Frequencies  
NAVAID Name  
FREQ, Ident, CH, Morse Code  
Latitude, Longitude  
Controlling FSS Name

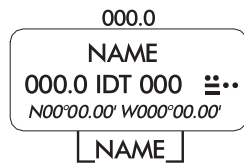

### HIGH ENROUTE CHARTS

RCO Frequencies  
NAVAID Name  
Frequency, Ident, Channel,  
Latitude, Longitude  
Controlling FSS Name

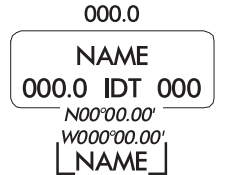

## COMMON ELEMENTS (HIGH AND LOW CHARTS)

### RCO Frequency

Single Frequency

Multiple Frequencies

Frequencies transmit and receive except those followed by R and T:

R - Receive Only      T - Transmit Only

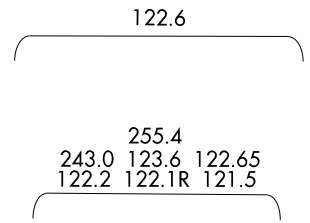

### NAVAID Box

Thin line NAVAIID boxes without frequency(s) and FSS radio name indicates no FSS frequencies available.

Shadow NAVAIID box indicates NAVAIID and Flight Service Station (FSS) have same name.

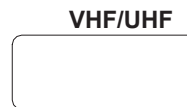

# RADIO AIDS TO NAVIGATION (Continued)

## Navigation and Communication Boxes - Common Elements

### Frequency Protection

Frequency Protection usable range at 18,000' AGL - 40 NM

(L)

Frequency Protection usable range at 12,000' AGL - 25 NM

(T)

### DISTANCE MEASURING EQUIPMENT

Facilities that operate in the "Y" mode for DME reception

(Y)

### VOICE COMMUNICATIONS VIA NAVAID

Voice Transmitted

112.6

No Voice Transmitted

111.0

### NAVAID SHUTDOWN STATUS

VHF/UHF

LF/MF

### PART TIME OR ON-REQUEST

VHF/UHF

LF/MF

### AUTOMATED WEATHER BROADCAST SERVICES

ASOS/AWOS - Automated Surface Observing Station/Automated Weather Observing Station

VHF/UHF

LF/MF

### LATITUDE AND LONGITUDE

Latitude and Longitude coordinates are provided for those NAVAIDs that make up part of a route/airway or a holding pattern. All TACAN facilities will include geographic coordinates.

#### LOW ENROUTE

$N00^{\circ}00.00' W000^{\circ}00.00'$

#### HIGH ENROUTE

$N00^{\circ}00.00' W000^{\circ}00.00'$

## Navigation and Communication Boxes - Examples

### LOW ENROUTE CHARTS

#### VOR

R - Receive only 122.1R

Controlling FSS Name - ANDERSON

122.1R  
ALLEDALE  
116.7 ALD   
N33°00.79' W81°17.53'  
[ANDERSON]

(T) - Service Volume

POLK (T)  
108.4 FXU

Receive & Transmit on 122.35

(T) - Service Volume

Latitude and Longitude

Controlling FSS Name - MACON

122.35  
TIFT MYERS (T)  
112.5 IFM   
N31°25.72' W83°29.33'  
[MACON]

### HIGH ENROUTE CHARTS

#### VOR

CECIL  
117.9 VQQ  
N30°12.78'  
W81°53.45'



# RADIO AIDS TO NAVIGATION (Continued)

## Navigation And Communication Boxes - Examples (Continued)

### LOW ENROUTE CHARTS

#### VOR/DME

No Voice Communications  
(Y) Mode DME

R - Receive only 122.1R  
Controlling FSS Name - BUFFALO

Shadow NAVAID Box  
FSS Associated with NAVAID

#### TACAN

TACAN Channels are without  
voice but not underlined

Part Time NAVAID

#### VORTAC

Shutdown status

#### DME

DME Channel, Ident, Morse Code,  
VHF Frequency

#### NDB

A - ASOS/AWOS Available

Shutdown status

#### NDB/DME

No Voice Communications  
(Y) Mode DME

Shadow NAVAID Box  
FSS Associated with NAVAID

Notes:

### HIGH ENROUTE CHARTS

#### VOR/DME

Off Route (Greyed NAVAID Box  
and NAVAID)

Service Volume - L  
DME in Y Mode

Shadow NAVAID Box  
FSS Associated with NAVAID

#### TACAN

Off Route

Off Route - Part Time NAVAID  
(Greyed NAVAID Box and NAVAID)  
Service Volume - L

#### VORTAC

Off Route (Greyed NAVAID Box  
and NAVAID)  
Service Volume - L

#### DME

DME Channel, Ident,  
VHF Frequency

#### NDB

#### NDB/DME

No Voice Communications  
(Y) Mode DME

Shadow NAVAID Box  
FSS Associated with NAVAID

Notes: Morse Code is not shown on High NAVAID Boxes.

# RADIO AIDS TO NAVIGATION (Continued)

## Stand Alone Flight Services and Communication Outlets

### Flight Service Station (FSS)

Shadow NAVAID boxes indicate Flight Service Station (FSS) locations. Frequencies 122.2, 255.4 and emergency 121.5 and 243.0 are available at many FSSs and are not shown. All other frequencies are show above the box.

Certain FSSs provide Local Airport Advisory (LAA) on 123.6.

Frequencies transmit and receive except those followed by R and T:

- R - Receive Only
- T - Transmit Only

*In Canada, shadow boxes indicate FSSs with standard group frequencies of 121.5, 126.7 and 243.0.*

### Remote Communications Outlet (RCO)

Thin line NAVAID boxes without frequencies and controlling FSS name indicate no FSS frequencies available. Frequencies positioned above the thin line boxes are remoted to the NAVAID sites. Other frequencies at the controlling FSS named are available, however altitude and terrain may determine their reception.

*In Canada, a "D" after the frequency indicates a dial-up remote communications outlet.*

### Stand Alone AWOS & ASOS

#### LOW CHARTS

#### HIGH CHARTS

Stand Alone FSS



Stand Alone FSS



Stand Alone FSS Associated with an Airport

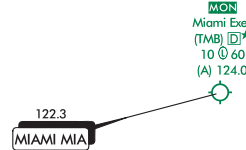

Stand Alone FSS Associated with an Airport



Part-time FSS

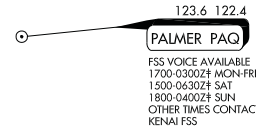

Stand Alone FSS within Canadian Airspace



Stand Alone FSS within Canadian Airspace

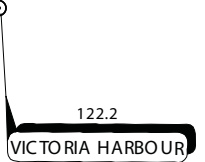

Stand Alone RCO



Stand Alone RCO

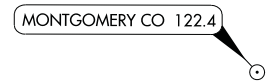

RCO Associated/Co-located with an Airport

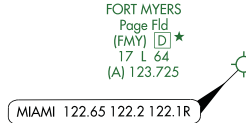

RCO Associated/Co-located with an Airport

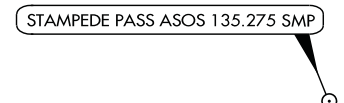
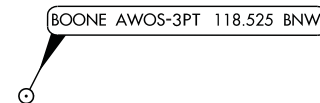
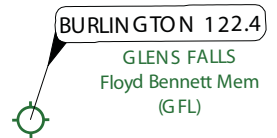

# AIRSPACE INFORMATION

## Airway/Route Types

### Low and High Enroute Airway Data:

VHF/UHF Data is depicted in Black.  
 LF/MF Data is depicted in Brown.  
 RNAV Route data is depicted in Blue

#### Low Enroute Charts

**Victor Airways** 

**LF/MF Airway** 

**Uncontrolled LF/MF Airway** 

**RNAV T Route** 

GNSS Required

**RNAV TK Helicopter Route** 

GNSS Required

**Preferred Single Direction Victor Route** 

**Unusable Route Segment** 

**Direction of Flight Indicator Canadian Routes Only** 

### Military Training Routes (MTR)

MTRs 5NM or less both sides of centerline 

MTRs greater than 5NM either or both sides of centerline 

Arrow indicates direction of route

See MTR tabulation for altitude range information

All IR and VR MTRs are shown except those VRs at or below 1500' AGL

CAUTION: Inset charts do not depict MTRs

#### Low and High Enroute Charts

**ATS Route** 

**Oceanic Route** 

#### High Enroute Charts

**Jet Routes** 

**Atlantic Routes** 

**Bahama Routes** 

**RNAV Q Routes** 

Alaska Q Routes require GNSS and radar surveillance. Within the CONUS, GNSS or DME/DME/IRU RNAV required, unless otherwise indicated. DME/DME/IRU aircraft require radar surveillance. Refer to Chart Supplement for DME information.

**Preferred Single Direction Jet Routes** 

**Preferred Single Direction RNAV Q Routes** 

**Single Direction ATS Route** 

**Unusable Route Segment** 

**By-Pass Route** 

Jet Route Centerline by-passing a facility which is not part of that specific route.

**Substitute Route** 

All relative and supporting data shown in brown.

See NOTAMS or appropriate publication for specific information.

# Airspace Information (Continued)

## FIXES

VHF/UHF



LF/MF



N25°46.47'  
W76°16.28'

N29°36.00'  
W88°01.00'

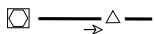
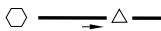

VHF/UHF

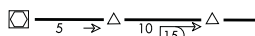

VHF/UHF

229

LF/MF

149

54

125

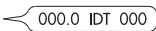

N/A

N/A



N/A

N/A

## REPORTING FUNCTION

**Compulsory Position Reporting**

**Non-Compulsory Position Reporting**

**Fix or Waypoint Coordinates**

Fix Coordinates are shown for compulsory, offshore and holding fixes.

Waypoints Coordinates are shown when waypoint is not part of a RNAV route and when located on or beyond the boundary of the U.S. Continental Control (12 mile limit).

**Off-set arrows indicate facility forming a fix**

- Arrow points away from the VHF/UHF NAVAID
- Arrow points towards the LF/MF NAVAID

**Distance Measuring Equipment (DME) Fix**

Denotes DME fix (distance same as airway / route mileage)

**Distance Measuring Equipment (DME) Fix**

Denotes DME fix (encircled mileage shown when not otherwise obvious)

**Example:**

First segment, 5NM; second segment 10NM; total mileage provided in encircled DME arrow.

**Total Mileages between Compulsory Reporting Points or NAVAIDs**

Note: All mileages are in Nautical Miles

**MILEAGE BETWEEN OTHER FIXES, NAVAIDS AND/OR MILEAGE BREAKDOWN**

**Mileage Breakdown or Computer Navigation Fix (CNF)**

Five letter identifier in parentheses indicates CNF with no ATC function

**FACILITY LOCATOR BOATS**

Crosshatch indicates Shutdown status of NAVAID

**RADIAL OUTBOUND FROM A VHF/UHF NAVAID**

All Radials are magnetic.

**BEARING INBOUND TO AN LF/MF NAVAID**

All Bearings are magnetic.

**MAGNETIC REFERENCE BEARING**, outbound from a NAVAID or Fix

Note: Not shown on joint Victor/RNAV or Jet/RNAV Routes.

## WAYPOINTS

RNAV



N44°25.36'  
W64°11.00'

N/A

N/A

RNAV

N/A

N/A

RNAV

N/A

125

N/A











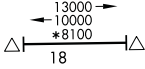

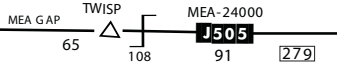



N/A

N/A

N/A

000 →

# Airspace Information (Continued)

VHF/UHF LOW CHARTS	LF/MF LOW CHARTS	MINIMUM ENROUTE ALTITUDE (MEA) All Altitudes Are MSL Unless Otherwise Noted.	RNAV LOW CHARTS
0000	0000	Directional MEAs	0000G
		MEAs are shown on IFR High Altitude Charts when MEA is other than 18,000'.	HIGH CHARTS
HIGH CHARTS MEA-29000	HIGH CHARTS MEA-FL240		MEA for GNSS RNAV aircraft MEA-24000G
			MEA for DME/DME/IRU RNAV aircraft MEA-24000D
<p><b>LOW CHARTS</b></p>  <p><b>HIGH CHARTS</b></p> 		<p><b>MINIMUM ENROUTE ALTITUDE (MEA) GAP</b></p> <p>MEA is established when there is a gap in navigation signal coverage.</p>	N/A
LOW / HIGH CHARTS MAA-00000	LOW / HIGH CHARTS MAA-00000	<p><b>Maximum Authorized Altitude (MAA)</b> All Altitudes Are MSL Unless Otherwise Noted.</p> <p>MAAs are shown on IFR High Altitude Charts when MAA is other than 45,000'.</p>	LOW / HIGH CHARTS MAA-00000
LOW CHARTS *0000	LOW CHARTS *0000	<p><b>Minimum Obstruction Clearance Altitude (MOCA)</b></p> <p>All Altitudes Are MSL Unless Otherwise Noted.</p>	LOW CHARTS *0000
LOW CHARTS 	LOW CHARTS 	<p><b>Minimum Turning Altitude (MTA) and Minimum Crossing Altitude (MCA)</b></p> <p>See Low Enroute Chart Example below for examples of both MTAs and MCAs.</p>	LOW CHARTS 
LOW CHARTS 	LOW CHARTS 	<p><b>MINIMUM RECEPTION ALTITUDE (MRA)</b></p>	N/A
LOW / HIGH CHARTS 	LOW / HIGH CHARTS 	<p><b>ALTITUDE CHANGE</b> MEA, MOCA and/or MAA change at other than NAVAIDs</p>	LOW / HIGH CHARTS 
LOW / HIGH CHARTS 	LOW / HIGH CHARTS 	<p><b>CHANGEOVER POINT</b></p> <p>Changeover Point giving mileage to NAVAIDs (Not shown at midpoint locations.)</p>	N/A
<p>RADDY N47°04.47' W121°30.97'</p> 	<p>LARGE N39°17.12' W69°18.07'</p> 	<p><b>HOLDING PATTERNS</b> RNAV Holding Pattern Magnetic Reference Bearing is determined by the isogonic value at the waypoint or fix.</p> <p>Holding Pattern with maximum restriction airspeed 210K applies to altitudes 6000' to and including 14000'. 175K applied to all altitudes. Airspeed depicted is Indicated Airspeed (IAS)</p>	



# AIRSPACE INFORMATION (Continued)

## Enroute Chart Examples Low Enroute Chart (Continued)

### Reference Number

### Description

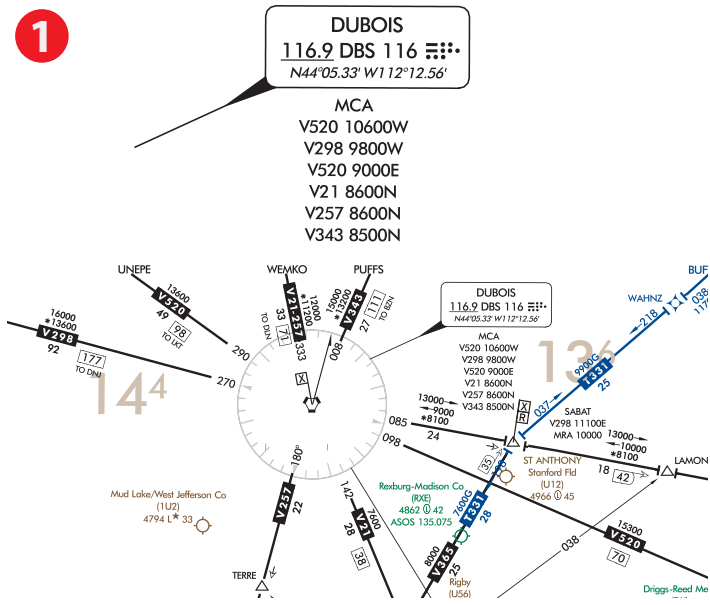

### Multiple MCAs at a NAVAID

V21 and V257 - MCA at DBS of 8600' traveling North  
V298 - MCA at DBS of 9800' traveling West  
V343 - MCA at DBS of 8500' traveling North  
V520 - MCA at DBS of 9000' traveling East  
V520 - MCA at DBS of 10600' traveling West

### MCA and MRA at a Fix

MCA at SABAT on V298 of 11,100 traveling East.  
MRA at SABAT of 10000.

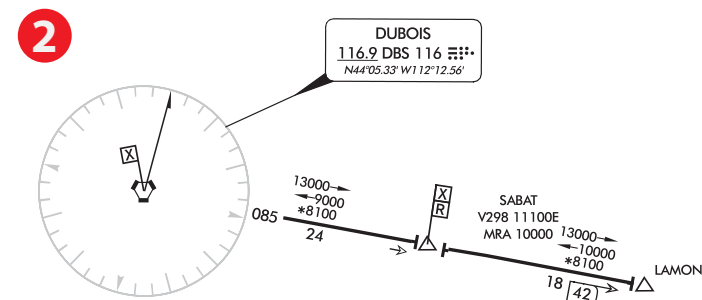

### Example of MOCA and directional MEAs along a Victor Route

Traveling East from DBS, MEA 13,000' the first two segments, 15,000 along third segment.

Traveling West from QUIRT, MEA of 15,000' the first segment, MEA of 10,000 the second segment and MEA of 9,000 the third segment.

MOCA for DBS to SABAT and SABAT to LAMON segments of 8100

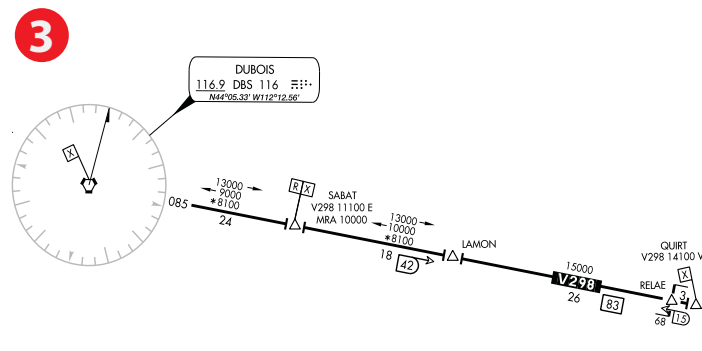

### MCA Example

MCA at OSITY on V330. MCA of 9500' traveling East on V330 from Idaho Falls (IDA) VOR-DME.

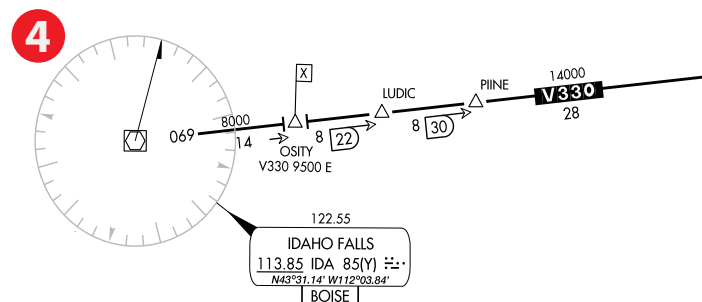

# AIRSPACE INFORMATION (Continued)

## Enroute Chart Examples

### Low Enroute Chart (Continued)

#### Reference Number

5

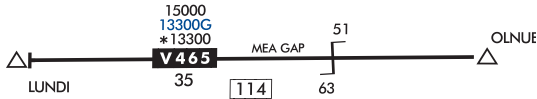

#### Description

##### MEA VHF and RNAV Example

MEA for aircraft utilizing VHF NAVAID of 15000'  
 MEA for aircraft utilizing RNAV of 13300'  
 MOCA of 13300'

6

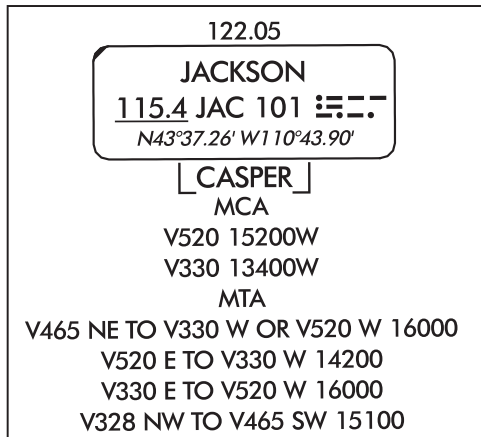

##### MCA and MTA Example at a NAVAID

MCA for aircraft traveling West along V520 to cross JAC at 15200'  
 MCA for aircraft traveling West along V330 to cross JAC at 13400'

MTA for aircraft crossing over and turning at JAC:

Aircraft traveling NE on V465 and turning to V330 on a W heading or turning to V520 on a W heading must turn at altitude of 16000' or higher

Aircraft traveling E on V520 and turning to V330 on a W heading must turn at altitude of 14200'

Aircraft traveling E on V330 and turning to V520 on a W heading must turn at altitude of 16000' or higher

Aircraft traveling NW on V328 and turning to V465 on a SW heading must turn at altitude of 15100' or higher.



# Airspace Information (Continued)

## Enroute Chart Examples

### High Enroute Chart

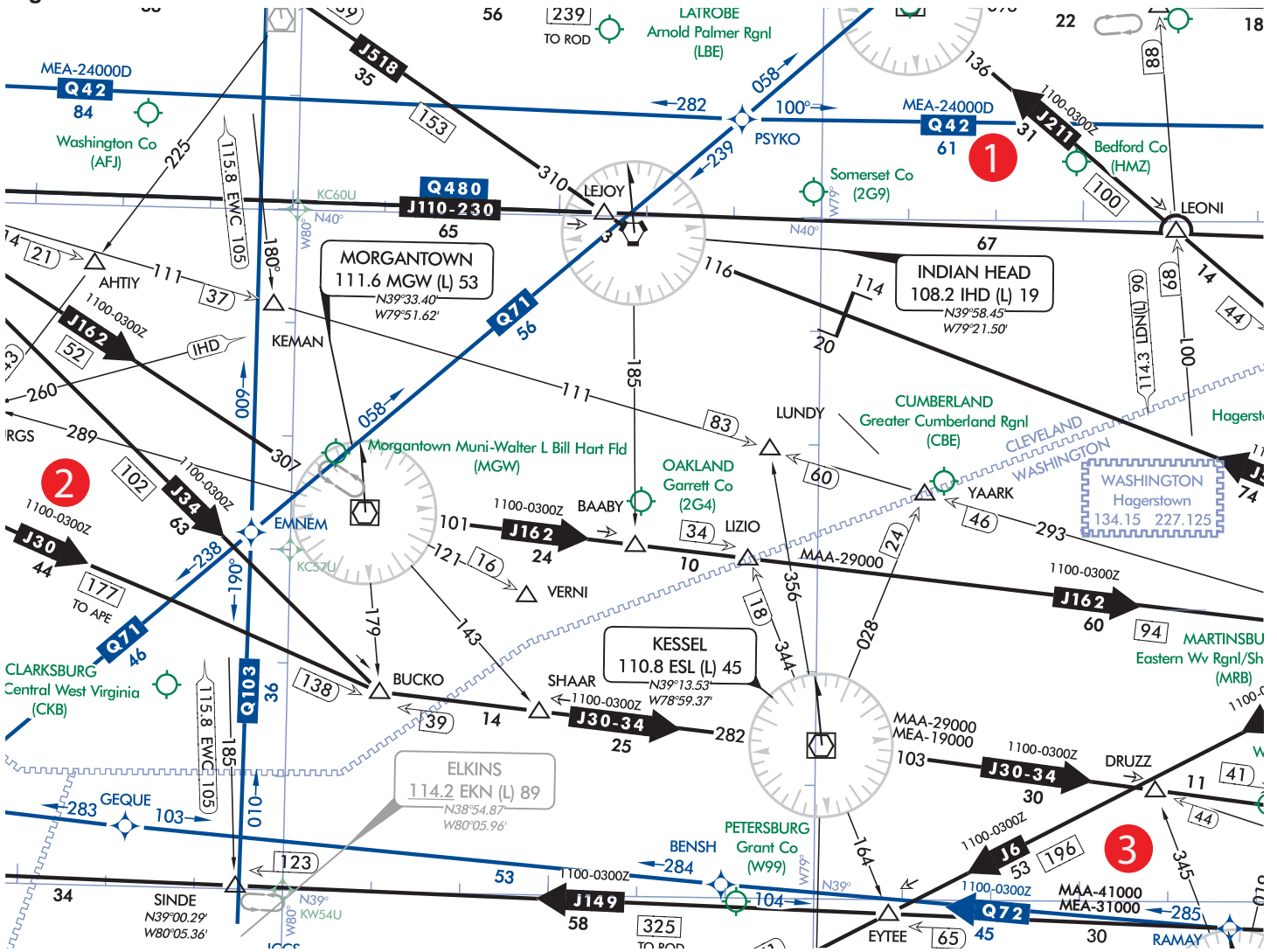

#### Reference Number

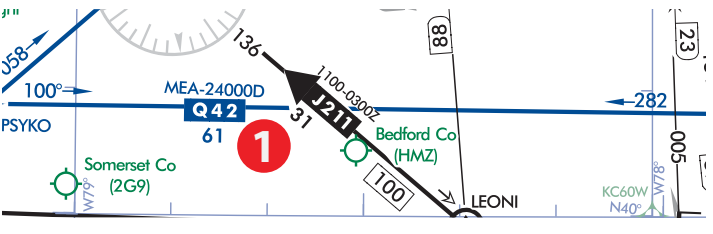

#### Description

**High RNAV Route with MEA for DME/DME/IRU RNAV Aircraft**  
 MEA of 24,000'

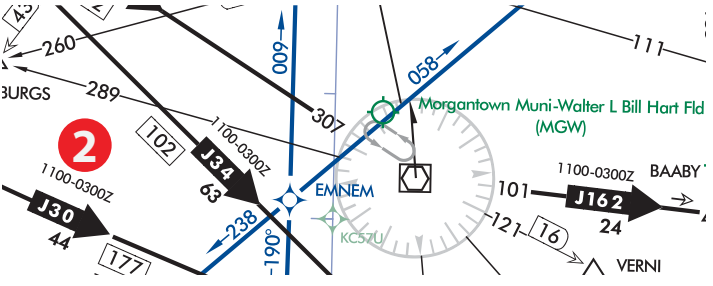

#### Directional Jet Route with Time Restrictions

Jet Route 34 available between 1100 - 0300Z

# AIRSPACE INFORMATION (Continued)

## Enroute Chart Examples High Enroute Chart (Continued)

### Reference Number

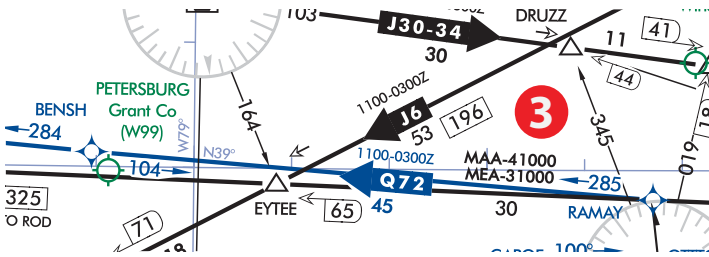

### Description

#### Directional Jet Route with Time Restrictions, MAA and MEA

Jet Route 149 available between 1100 - 0300Z  
 MAA - 41,000'  
 MEA - 31,000'

## AIRSPACE BOUNDARIES

### Air Defense Identification Zone (ADIZ)

#### LOW / HIGH CHARTS

CONTIGUOUS U.S. ADIZ

ALASKA ADIZ  
 CANADA ADIZ

#### Adjoining ADIZ

### Air Traffic Service Identification Data

#### LOW / HIGH CHARTS

CTA  
 HOUSTON OCEANIC  
 KZHU  
 UNLTD  
 2500 AMSL  
 NEW YORK RADIO  
 129.4 2887  
 5550 6577 8846 8918  
 11396 13297 17907

Ceiling  
 Floor  
 Call Sign  
 Frequency

FIR  
 HOUSTON OCEANIC  
 KZHU  
 UNLTD  
 AMSL  
 NEW YORK RADIO  
 129.4 2887  
 5550 6577 8846 8918  
 11396 13297 17907

Ceiling  
 Floor  
 Call Sign  
 Frequency

### Flight Information Regions (FIR)

#### LOW / HIGH CHARTS

TORONTO FIR CZYZ  
 MONTREAL FIR CZUL  
 TORONTO FIR CZYZ

### Upper Information Regions (UIR)

### Upper Control Areas (UTA)

HIGH ALTITUDE  
 MONTERREY UTA/UIR SECTOR 2 MMTY  
 MERIDA UTA/UIR SECTOR 1 MMID  
 MONTERREY UTA/UIR SECTOR 1 MMTY  
 HOUSTON OCEANIC CTA/FIR KZHU  
 MONTERREY FIR/UIR MMTY

Adjoining UTA / UIR  
 Adjoining FIR and UIR

### Air Route Traffic Control Center (ARTCC)

ARTCC Remoted Sites with discrete VHF and UHF frequencies

#### LOW / HIGH CHARTS

NEW YORK  
 WASHINGTON  
 NEW YORK  
 Barnegat  
 132.15

ARTCC Name  
 Site Name  
 Frequency

### Air Route Traffic Control Center (ARTCC) with Controller Pilot Data Link Communications (CPDLC)

ATLANTA  
 JACKSONVILLE  
 CPDLC (LOGON KUSA)  
 CPDLC (LOGON KUSA)  
 ATLANTA  
 JACKSONVILLE  
 CPDLC (LOGON KUSA)

### Altimeter Setting Change

QNH  
 ALTIMETER  
 ONE 29.92

### Control Areas (CTA)

#### LOW / HIGH CHARTS

NEW YORK OCEANIC CTA/FIR KZHY  
 MIAMI OCEANIC CTA/FIR KZMA

#### Adjoining CTA

### Additional Control Areas

LOW ALTITUDE

HIGH ALTITUDE

CONTROL 1141L  
 CONTROL 1419 H

# AIRSPACE INFORMATION (Continued)

## Airspace - U.S.

**Class A** Open Area (White)

**High Chart Only** That airspace from 18,000' MSL to and including FL 600, including the airspace overflying the waters within 12 NM of the coast of the contiguous United States and Alaska and designated offshore areas, excluding Santa Barbara Island, Farallon Island, the airspace south of latitude 25° 04'00" N, the Alaska peninsula west of longitude 160°00'00" W, and the airspace less than 1,500' AGL.

**Controlled Airspace**

That airspace from 18,000' MSL to and including FL 450, including Santa Barbara Island, Farallon Island, the Alaska peninsula west of longitude 160°00'00" W, and designated offshore areas.

## Class B

Screened Blue with a Solid Blue Outline

Low Chart Only

Controlled Airspace

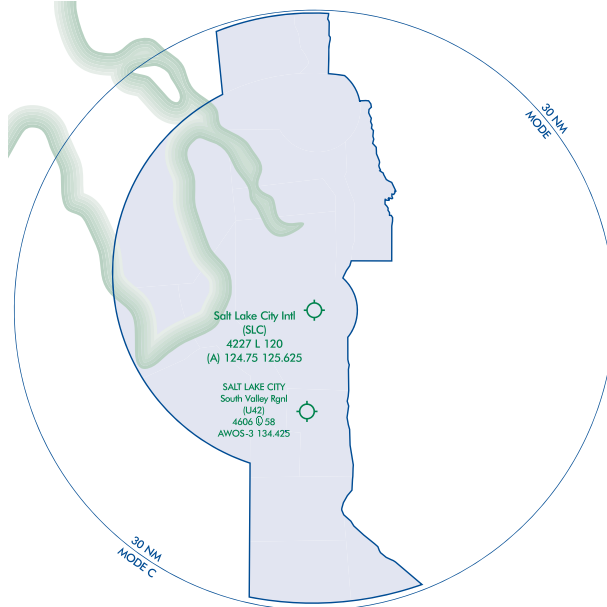

Example:

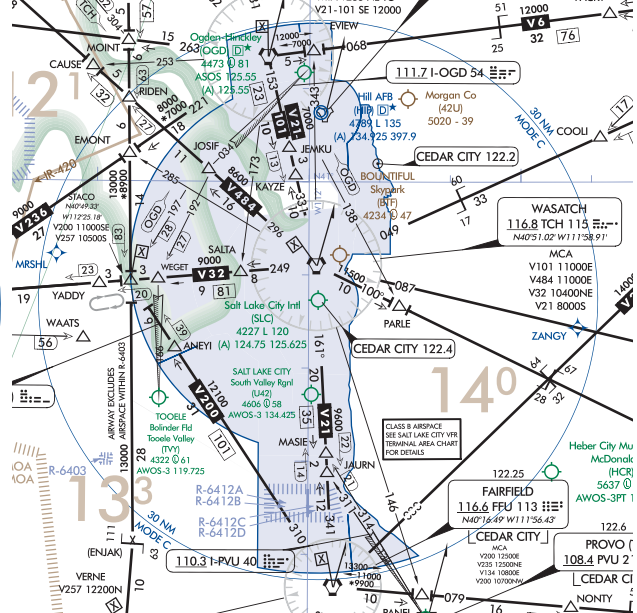

That airspace from the surface to 10,000' MSL (unless otherwise designated) surrounding the nation's busiest airports. Each Class B airspace area is individually tailored and consists of a surface area and two or more layers.

## Mode C Area

A Solid Blue Outline

Low Chart Only

Controlled Airspace

That airspace within 30 NM of the primary airports of Class B airspace and within 10 NM of designated airports. Mode-C transponder equipment is required. (See FAR 91.215)

Example:

See Chart example above.

FAA Chart Users' Guide - IFR Enroute Symbolology

# AIRSPACE INFORMATION (Continued)

## Airspace - U.S. (Continued)

### CLASS C

Screened Blue with a Solid Blue Dashed Outline

Low Chart Only

Controlled Air-space

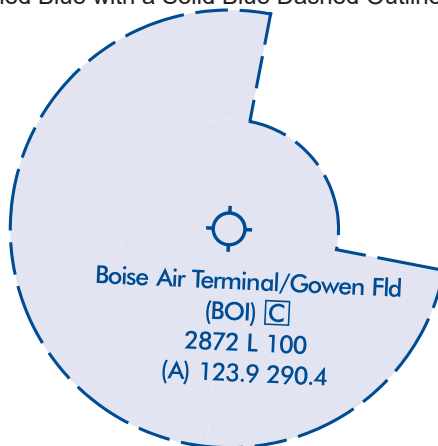

That airspace from the surface to 4,000' (unless otherwise designated) above the elevation of selected airports (charted in MSL). The normal radius of the outer limits of Class C airspace is 10NM. Class C airspace is also indicated by the letter C in a box following the airport name.

Example:

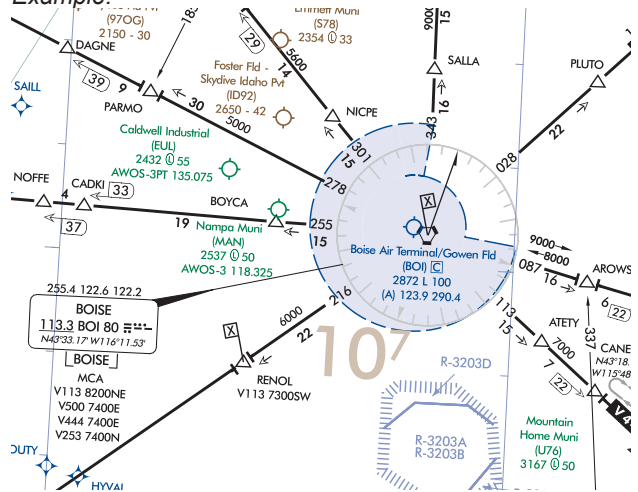

### CLASS D

Open Area (White)

Low Chart Only

Controlled Air-space

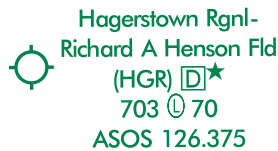

That airspace from the surface to 2,500' unless otherwise designated) above the airport elevation (charted in MSL), surrounding those airports that have an operational control tower. Class D airspace is indicated by the letter D in a box following the airport name.

Example:

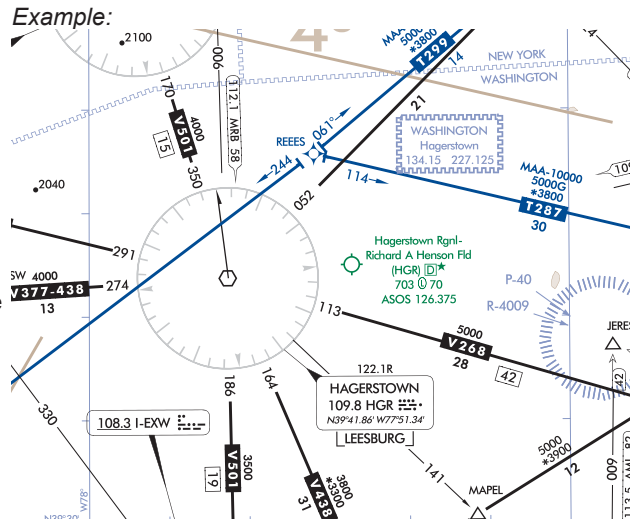

### CLASS E

Open Area (White)

Low Chart Only

Controlled Air-space

That controlled airspace below 14,500' MSL which is not Class B, C or D.

Federal Airways from 1,200' AGL to but not including 18,000' MSL (unless otherwise specified).

Other designated control areas below 14,500' MSL.

Not Charted

That airspace from 14,500' MSL to but not including 18,000' MSL, including the airspace overlying the waters within 12 NM of the coast of the contiguous United States and Alaska and designated offshore areas, excluding the Alaska peninsula west of longitude 160°00'00" W, and the airspace less than 1,500' AGL.

# Airspace Information (Continued)

## AIRSPACE - U.S.

**CLASS G** Screened Brown Area

High and Low Chart

Uncontrolled Airspace

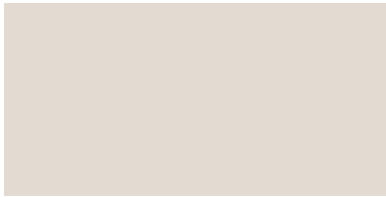

Low Altitude

That portion of the airspace below 14,500' MSL that has not been designated as Class B, C, D or E Airspace.

High Altitude

That portion of the airspace from 18,000' MSL and above that has not been designated as Class A airspace.

Example:

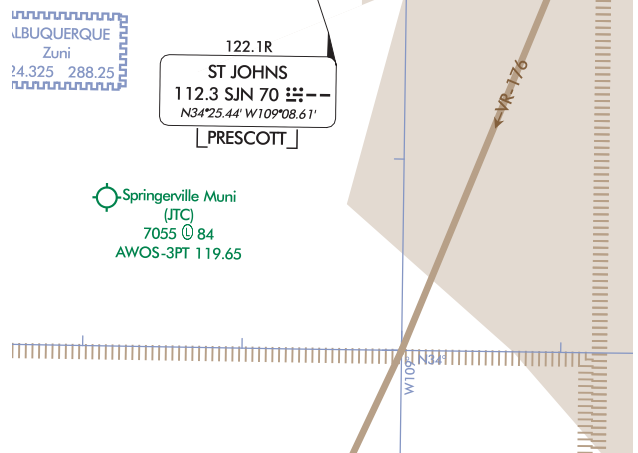

## AIRSPACE - CANADIAN

**CLASS B** Screened Brown Checkered Area

Low Charts Only

Controlled Airspace

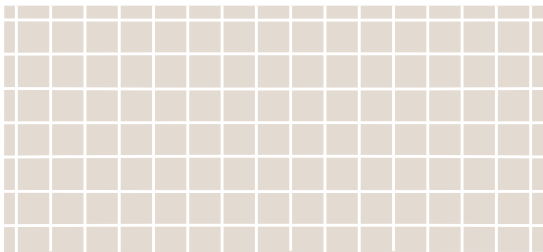

Controlled airspace above 12,500' MSL

Example:

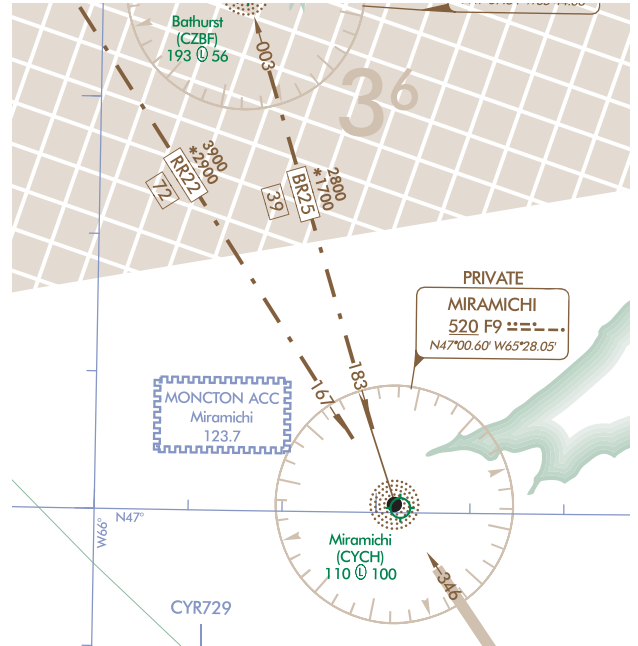

# AIRSPACE INFORMATION (Continued)

## Special Use Airspace - U.S.

Low and High Charts P - Prohibited Area

Example: P-56 - Washington DC, Area A-1 Chart



Example: P-40 and R-4009 - Washington DC, Area A-1 Chart

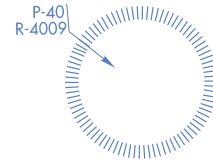

R - Restricted Area

Example: R3601A -



W - Warning Area

Example: W-50

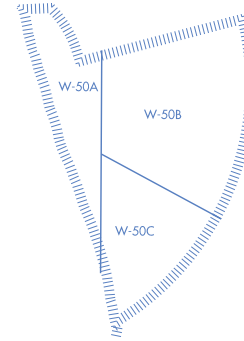

See Airspace Tabulation on each chart for complete documentation information on:

- Area Identification
- Effective Altitude
- Operating Times
- Controlling Agency Voice Call

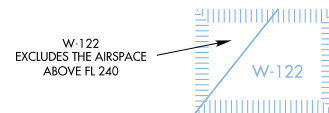

Low Charts Only

A - Alert Area

\* Alert Areas do not extend into Class A, B, C and D airspace, or Class E airport surface areas.



MOA - Military Operations Area

See Airspace Tabulation on each chart for complete documentation information on:

- Area Identification
- Effective Altitude
- Operating Times
- Controlling Agency Voice Call

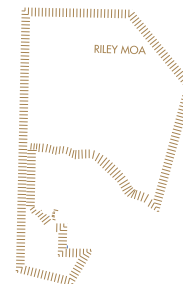

# AIRSPACE INFORMATION (Continued)

## Off Route Obstruction Clearance Altitude (OROCA)

*Low Charts Only* OROCA is computed similarly to the Maximum Elevation Figure (MEF) found on Visual charts except that it provides an additional vertical buffer of 1,000 feet in designated non-mountainous areas and a 2,000 foot vertical buffer in designated mountainous areas within the United States.

Example: 12,500 feet

12<sup>5</sup>

Example: Low L-13 Chart

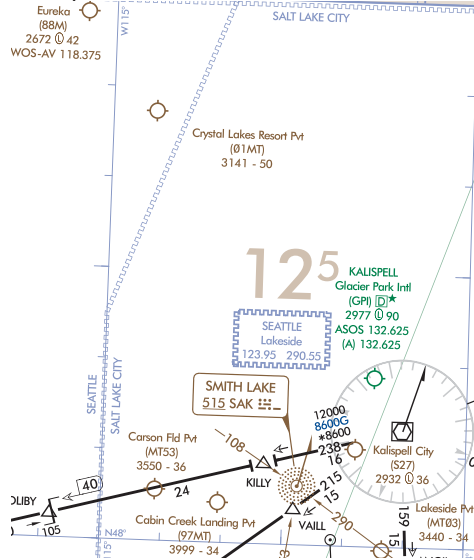

## Special Flight Rules Area (SFRA)

*Low and High Charts* SFRA Symbology



Example: Low Chart (Washington Area Chart)

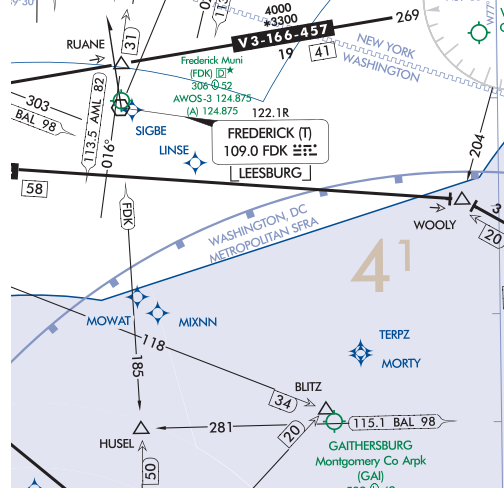

Example: High Chart (H-12)

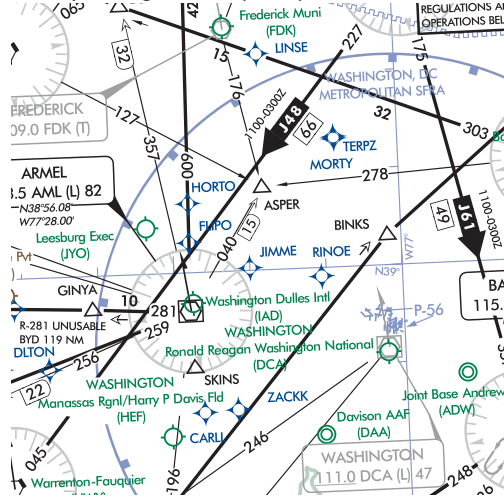

# AIRSPACE INFORMATION (Continued)

## Special Use Airspace - Canada & Caribbean

Low and High Charts  
 Canada Only  
 CYA - Advisory Area

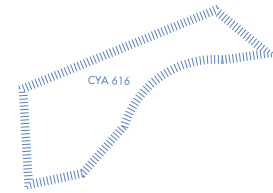

CYD - Danger Area



CYR - Restricted Area



Caribbean Only  
 D - Danger Area

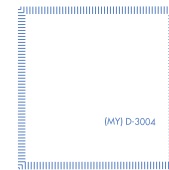

In the Caribbean, the first two letters represent the country code, i.e. (MY) Bahamas, (MU) Cuba

## NAVIGATIONAL AND PROCEDURAL INFORMATION

### Cruising Altitudes - Low Charts - U.S. Only

IFR outside controlled airspace.

IFR within controlled airspace as assigned by ATC.

ALL courses are magnetic.

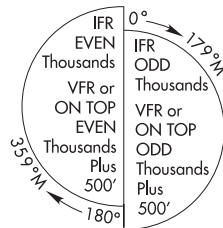

VFR above 3000' AGL unless otherwise authorized by ATC.

### Cruising Altitudes - High Charts - U.S. Only

IFR within controlled airspace as assigned by ATC

All courses are magnetic.

#### 18,000' MSL to FL280

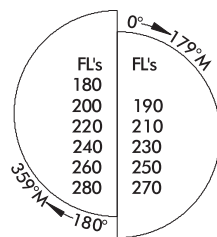

VFR or VFR On Top add 500'

No VFR flights within Class A Airspace above 3000' AGL unless otherwise authorized

#### RVSM Levels FL290 to FL410

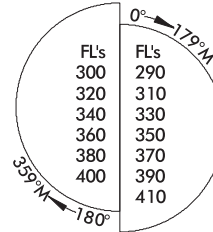

No VFR or VFR On Top authorized above FL285 in RVSM airspace.

#### FL430 and above

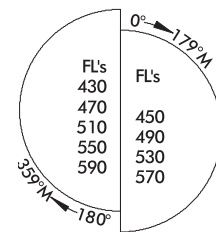



# Navigational and Procedural Information (Continued)

## ISOGONIC LINE AND VALUE

## LOW/HIGH CHARTS

## ENLARGEMENT AREA



## MORSE CODE

A	..	F	....	K	---	P	----	U	...	1	-----	6	.....
B	....	G	---	L	....	Q	----	V	....	2	-----	7	.....
C	----	H	....	M	---	R	---	W	---	3	-----	8	-----
D	---	I	..	N	..	S	...	X	----	4	-----	9	-----
E	.	J	----	O	---	T	-	Y	----	5	.....	0	-----
								Z	----				

## TIME ZONE

All time is Coordinated Universal Time (UTC)

Mountain Std  
+7 = UTC

Central Std  
+6 = UTC

During periods of Daylights Savings Time (DT), effective hours will be one hour earlier than shown. All states observe DT except Arizona and Hawaii

## MATCH MARK

## LOW/HIGH CHARTS



## CULTURE

### Boundaries

#### International

#### LOW/HIGH ALTITUDE

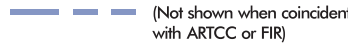

#### U.S./Russia Maritime Line

#### LOW/HIGH ALTITUDE



## HYDROGRAPHY

## SHORELINES



## TOPOGRAPHY

### TERRAIN

Area Charts



## Date Line

#### LOW/HIGH ALTITUDE





# U.S. TERMINAL PROCEDURES PUBLICATION

The U.S. Terminal Procedures Publication (TPPs) includes the Instrument Approach Procedures (IAPs), Departure Procedures (DPs) charts, Standard Terminal Arrival (STAR) charts, Charted Visual Flight Procedure (CVFP) charts, and Airport Diagrams. Also included are Takeoff Minimums, (Obstacle) Departure Procedures, Diverse Vector Area (RADAR Vectors), RADAR and Alternate Minimum textual procedures.

## EXPLANATION OF TPP TERMS AND SYMBOLS

The information and examples in this section are based primarily on the IFR (Instrument Flight Rules) Terminal Procedures Publication (TPP). The publication legends list aeronautical symbols with a brief description of what each symbol depicts. This section will provide more detailed information of some of the symbols and how they are used on TPP charts.

FAA Terminal charts are prepared in accordance with specifications of the Interagency Air Committee (IAC) and their supporting technical groups for the purpose of standardization, which are approved by representatives of the Federal Aviation Administration (FAA), and the Department of Defense (DoD).

The Terminal Procedure Publication is made up of the following charts:

- Instrument Approach Procedure (IAP) Charts
- Airport Diagrams
- Departure Procedures (DP)
- Standard Terminal Arrival (STAR) Charts
- Charted Visual Flight Procedure (CVFP) Charts

# INSTRUMENT APPROACH PROCEDURE CHART

The IAPs (charts) are divided into various sections:

Margin Identification Information  
 Briefing Strip Information  
 Planview  
 Missed Approach Information

Profile View  
 Landing Minimums  
 Airport Sketch

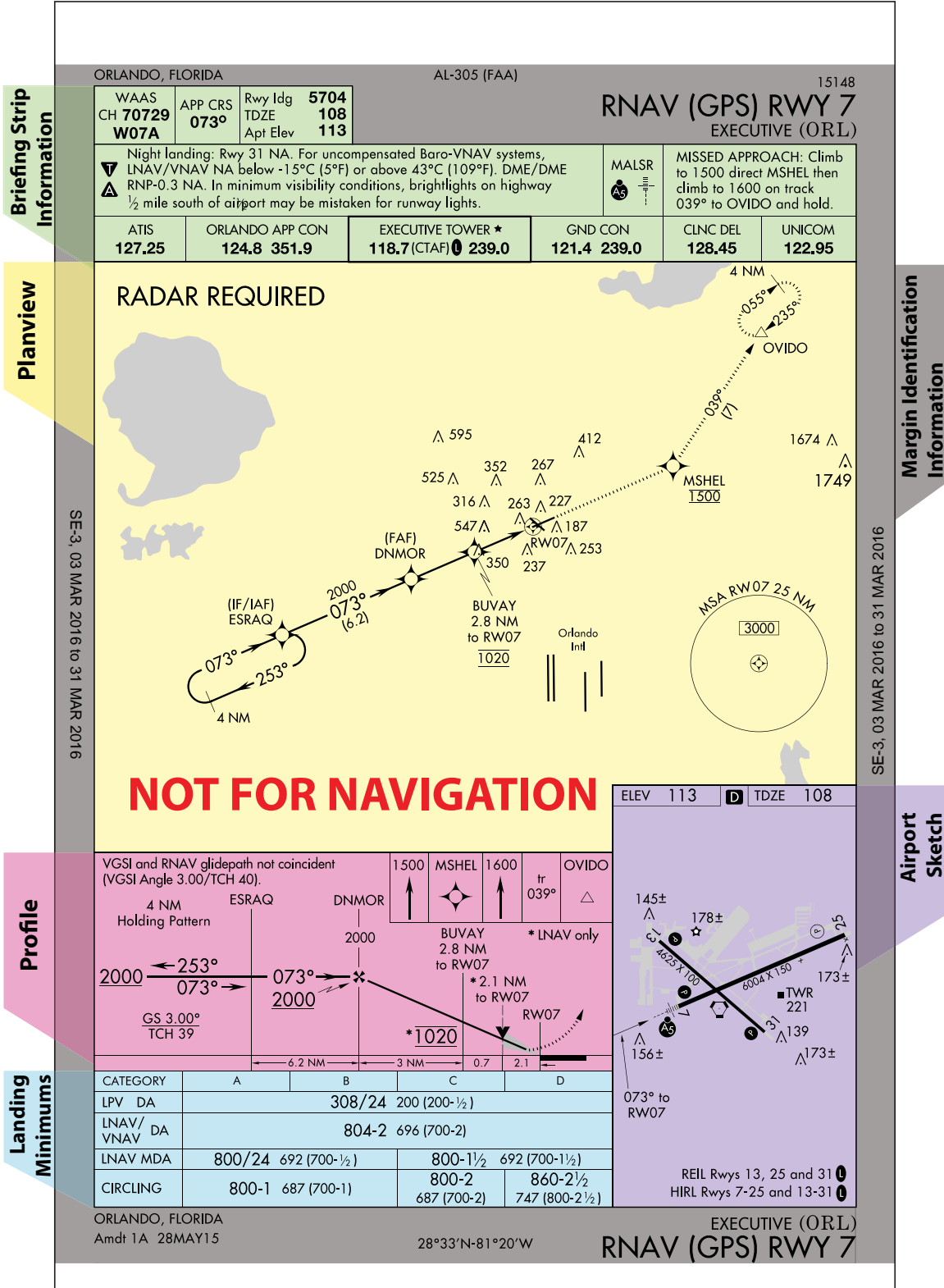

FAA Chart Users' Guide - Terminal Procedures Publication (TPP) - Terms

**Margin Identification Information**

CITY, STATE	AL-0000 (FAA)	00000
		<b>RNAV (GPS) RWY 00</b> AIRPORT NAME (XXX)
-----		
VOL, DD MMM YYYY to DD MMM YYYY		VOL, DD MMM YYYY
-----		
CITY, STATE Orig DDMMYY	00°00'N-000°00'W	AIRPORT NAME (XXX) <b>RNAV (GPS) RWY 00</b>

FAA Chart Users' Guide - Terminal Procedures Publication (TPP) - Terms

The margin identification at the top, bottom, and sides of the chart provides information about the airport location, procedure identification, and chart currency. The charts are organized by city first, then airport name and state, with the exception of military charts, which are organized by airport name. Going from the top of the chart, reading from left to right, and going down the chart, Margin Identification Information is organized in the following way.

The hash marks along the top and bottom borders of military Instrument Approach Charts indicate that the procedure was designed using High Altitude criteria contained in FAA Order 8260.3. These procedures are designed to support high performance military aircraft operations and are not intended for civilian use.



**Top Margin Information:**

The city and state with which the airport is associated is located on both the top and bottom margins.

At the center of the top margin is the FAA numbering system. This Approach and Landing (AL) number is followed by the organization responsible for the procedure in parentheses, e.g., AL-18 (FAA), AL-227 (USAF).

WASHINGTON, DC	AL-5326 (FAA)	15344				
<table border="0" style="width: 100%; border-collapse: collapse;"> <tr> <td style="width: 20%;">WAAS CH <b>56239</b> <b>W34B</b></td> <td style="width: 20%;">APP CRS <b>326°</b></td> <td style="width: 20%;">Rwy Idg TDZE Apt Elev</td> <td style="width: 40%; text-align: right; vertical-align: top;"> <b>3715</b> <b>182</b> <b>192</b> </td> </tr> </table>	WAAS CH <b>56239</b> <b>W34B</b>	APP CRS <b>326°</b>	Rwy Idg TDZE Apt Elev	<b>3715</b> <b>182</b> <b>192</b>	<b>RNAV (GPS) RWY 34L</b> MANASSAS RGNL/HARRY P DAVIS FIELD (HEF)	
WAAS CH <b>56239</b> <b>W34B</b>	APP CRS <b>326°</b>	Rwy Idg TDZE Apt Elev	<b>3715</b> <b>182</b> <b>192</b>			

The procedure title is located on both the top and bottom margins. It is derived from the type of navigational facility that is providing the final approach course guidance. The title is abbreviated, e.g. ILS, RNAV, NDB, etc. For airports with parallel runways and simultaneous approach procedures, "L", "R" or "C" follows the runway number to distinguish between left, right, and center runways.

The airport name is shown on both the top and bottom margins below the procedure title. The airport identifier is shown in parentheses following the airport name. Airports outside the contiguous United States will be shown with the FAA designated identifier followed by the ICAO location identifier.

The Date of Latest Revision is shown on the top margin above the procedure title. The Date of Latest Revision identifies the Julian date the chart was last revised for any reason. The first two digits indicate the year, the last three digits indicate the day of the year (001 to 365/6).

WASHINGTON, DC	AL-5326 (FAA)	15344				
<table border="0" style="width: 100%; border-collapse: collapse;"> <tr> <td style="width: 20%;">WAAS CH <b>56239</b> <b>W34B</b></td> <td style="width: 20%;">APP CRS <b>326°</b></td> <td style="width: 20%;">Rwy Idg TDZE Apt Elev</td> <td style="width: 40%; text-align: right; vertical-align: top;"> <b>3715</b> <b>182</b> <b>192</b> </td> </tr> </table>	WAAS CH <b>56239</b> <b>W34B</b>	APP CRS <b>326°</b>	Rwy Idg TDZE Apt Elev	<b>3715</b> <b>182</b> <b>192</b>	<b>RNAV (GPS) RWY 34L</b> MANASSAS RGNL/HARRY P DAVIS FIELD (HEF)	
WAAS CH <b>56239</b> <b>W34B</b>	APP CRS <b>326°</b>	Rwy Idg TDZE Apt Elev	<b>3715</b> <b>182</b> <b>192</b>			
<span style="font-size: 2em; font-weight: bold; color: #008000;">15344</span> Year Day of Year						

**Side Margin Information:**

The side margins show the volume identification, i.e. SW-3, followed by the current issue date and the next issue date, e.g. SW-3, 21 JUL 2016 to 15 SEP 2016.

**Bottom Margin Information:**

The FAA Procedure Amendment Number, located on the left bottom margin below the City, State, represents the most current amendment of a given procedure. The Procedure Amendment Effective Date represents the AIRAC cycle date on which the procedure amendment was incorporated into the chart. Updates to the amendment number and effective date represent procedural/criteria revisions to the charted procedure, e.g., course, fix, altitude, minima, etc.

Example: Original Procedure Date

WASHINGTON, DC Orig 10DEC15	MANASSAS RGNL/HARRY P DAVIS FIELD (HEF) 38°43'N-77°31'W	15344 <b>RNAV (GPS) RWY 34L</b>
--------------------------------	--	------------------------------------

Example: Amendment Procedure Date

WASHINGTON D.C. Amdt 1B 28MAY15	MANASSAS RGNL/HARRY P DAVIS FIELD (HEF) 38°43'N-77°31'W	15344 <b>RNAV (GPS) RWY 16R</b>
------------------------------------	--	------------------------------------

The coordinates for the airport reference point are located at the center of the bottom margin.

## BRIEFING STRIP INFORMATION

At the top of every TPP is the Briefing Strip which consists of three stacked strips of information immediately above the planview. Information varies depending upon the type of procedure.

WASHINGTON, DC AL-443 (FAA) 15288

<b>Top Briefing Strip</b> LOC/DME I-DCA App CRS Rwy Idg 6869 TDZE 14 Apt Elev 15 Chan 36		<b>Middle Briefing Strip</b> Circling NA NE of Rwy 15-33 Night landing Rwy 4, 15 NA For inoperative ALSF-2, increase S-LOC 1, Cat C and D visibility to 1 1/2 mile. ALSF-2 MISSED APPROACH: Climb to 420 then climbing left turn to 2100 on DCA VOR/DME R 325 to GTN NDB/INT/DCA 5.9 DME and hold	
<b>Communications Briefing Strip</b> ATIS 132.65 POTOMAC APP CON 119.85 124.2 269.0 (EAST)		CLNC DEL 128.25	

ILS or LOC/DME RWY 1  
RONALD REAGAN WASHINGTON NATIONAL (DCA)

### Top Briefing Strip

The top briefing strip contains procedural information in three separate boxes, in the following sequence from left to right:

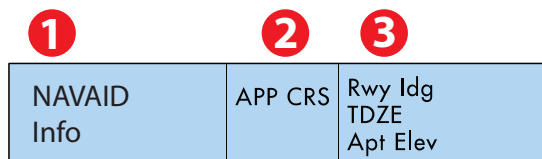

- Box 1: Primary Procedure Navigation Information:** The primary navigation type (VOR, LOC, NDB, RNAV, etc.) with its identifier and frequency/channel. If applicable, WAAS, the WAAS Channel Number, and the WAAS Reference Path indicator are shown stacked top to bottom. If the primary navigation type is GBAS, then the following information is shown, stacked top to bottom: GBAS, CH NNNN, RPI XXXX. If there is not a primary Navigation Box required, the first box is removed.
- Box 2: Final Approach Course Information.** The inbound Approach Course (APP CRS) is shown.
- Box 3: Runway Landing Information:** Stacked top to bottom, the runway landing distance (Rwy Ldg), the Touchdown Zone Elevation (TDZE), and the Airport Elevation (Apt Elev) are shown. Rwy Ldg may not reflect full runway length due to displaced thresholds and shorter declared distances.

Top Briefing Strip Examples:

Ground based NAVAID:

DENVER, COLORADO 16147

LOC/DME I-DZG <b>111.55</b> Chan 52(Y)	APP CRS <b>082°</b>	Rwy Idg <b>12000</b> TDZE <b>5352</b> Apt Elev <b>5434</b>
--	------------------------	--

ILS or LOC RWY 7  
DENVER INTL (DEN)

RNAV-WAAS:

DENVER, COLORADO 16147

WAAS CH <b>82628</b> <b>W16B</b>	APP CRS <b>173°</b>	Rwy Idg <b>16000</b> TDZE <b>5326</b> Apt Elev <b>5434</b>
--	------------------------	--

RNAV (GPS) Y RWY 16R  
DENVER INTL (DEN)

GBAS:

NEWARK, NEW JERSEY AL-285 (FAA) 18256

GBAS CH <b>22727</b> <b>G04A</b>	APP CRS <b>039°</b>	Rwy Idg <b>8460</b> TDZE <b>10</b> Apt Elev <b>17</b>
--	------------------------	---

GLS RWY 4L  
NEWARK LIBERTY INTL (EWR)

No Primary NAVAID box:

DENVER, COLORADO

16147

APP CRS <b>173°</b>	Rwy Idg TDZE Apt Elev	<b>12000</b> <b>5339</b> <b>5434</b>
------------------------	-----------------------------	--

**RNAV (RNP) Z RWY 17L**  
DENVER INTL (DEN)

Circling Approach:

ROANOKE, VIRGINIA

AL-349 (FAA)

16203

VOR ODR <b>114.9</b>	APP CRS <b>236°</b>	Rwy Idg TDZE Apt Elev	<b>N/A</b> <b>N/A</b> <b>1175</b>
-------------------------	------------------------	-----------------------------	---

**VOR/DME-A**  
ROANOKE-BLACKSBURG RGNL/WOODRUM FIELD (ROA)

Sidestep Procedure:

LOS ANGELES, CALIFORNIA

AL-237 (FAA)

16315

LOC/DME I-OSS <b>108.5</b> Chan <b>22</b>	APP CRS <b>251°</b>	Rwy Idg TDZE Apt Elev	<b>24R</b> <b>8925</b> <b>120</b> <b>126</b>	<b>24L</b> <b>9483</b> <b>121</b> <b>126</b>
---	------------------------	-----------------------------	---	---

**ILS or LOC RWY 24R**  
LOS ANGELES INTL (LAX)

### Middle Briefing Strip

The middle briefing strip may contain information in up to three separate boxes, when available, in the following sequence from left to right:

1

2

3

<b>NOTES BOX</b>	<b>APPROACH LIGHTING SYSTEM</b>	<b>MISSED APPROACH PROCEDURE TEXT BOX</b>
------------------	---------------------------------	---

- **Box 1: Notes Box:** contains procedure notes, Equipment/Requirements Notes box and Takeoff, Alternate, RADAR, WAAS, and/or Cold Weather indicators (details provided below under Notes Box).
- **Box 2: Approach Lighting System Box (when applicable):** shows the approach lighting system name and charting icon. Multiple approach lighting systems may be shown for approaches that have straight-in minimums for parallel runways.
- **Box 3: Missed Approach Procedure Text Box:** The full textual description of the missed approach procedure is provided here.

### Notes Box

#### Procedure Equipment Requirements Notes Box

Users will begin to see Performance-Based Navigation (PBN) Requirements and ground-based Equipment Requirements prominently displayed in separate, standardized notes boxes. For procedures with PBN elements, the PBN box will contain the procedure's navigation specification(s); and, if required: specific sensors or infrastructure needed for the navigation solution; any additional or advanced functional requirements; the minimum Required Navigation Performance (RNP) value and any amplifying remarks. Items listed in this PBN box are REQUIRED. The separate Equipment Requirements Box will list ground-based equipment requirements.

RADAR required for procedure entry.
 Simultaneous approach authorized with Rwy 21L. # RVR 1800 authorized with use of FD or AP or HUD to DA.









On procedures with both PBN elements and ground-based equipment requirements, the PBN requirements box will be listed first.

PBN Requirements Box	From WINRZ, LIBGE: RNAV-1 GPS, RNAV-1GPS from MAP to YARKU.
Equipment Requirements Box	DME required for LOC only.
Standard Procedure Notes Box	 Circling to Rwy 25 NA at night. #For inop MALSRL increase S-ILS 16R all cats visibility to 2½ SM.

## Notes Symbols

Several different symbols may appear within the Notes Box:

-  Non-Standard Takeoff minimums and/or Departure Procedures exist. Refer to Takeoff Minimum, (Obstacle) Departure Procedures, and Diverse Vector Area (RADAR VECTORS) section of the TPP
-  Non-standard IFR alternate minimums exist. Refer to IFR Alternate Airport Minimums section of the TPP.
-  NA Alternate minimums are not authorized due to unmonitored facility or absence of weather reporting service.
-  WAAS (Wide Area Augmentation System)
-  -12°C Cold Temperature Restricted Airport

The negative  within a black square box symbol shown in the Notes section below any “A” or “T” Symbol indicates that outages of the WAAS (Wide Area Augmentation System) vertical guidance may occur daily at this location due to initial system limitations. WAAS NOTAMs for vertical outages are not provided for this approach. Use LNAV minima for flight planning at these locations, whether as a destination or alternate. For flight operations at these locations, when the WAAS avionics indicate that LNAV/VNAV or LPV service is available, then vertical guidance may be used to complete the approach using the displayed level of service. Should an outage occur during the procedure, reversion to LNAV minima may be required.

When  -12°C appears in the Notes section below all other symbols it indicates a cold temperature altitude correction is required at that airport when the reported temperature is at or below the published restricted temperature. Advise ATC when altitude correction is made in the intermediate and/or missed approach segment. Reporting corrections to ATC in final segment is not required. See Notices to Airmen Publication (NTAP) Graphic Notices General for complete list of published airports, temperature/s, segments and procedure information.

When “ASR”, “PAR” or “ASR/PAR” appear in the Note section immediately below the “T” and “A” symbols it indicates there are published Radar Instrument Approach Minimums. Where radar is approved for approach control service, it is used not only for radar approaches (Airport Surveillance Radar [ASR] and Precision Approach Radar [PAR]) but is also used to provide vectors in conjunction with published non-radar approaches based on radio NAVAIDs (ILS, VOR, NDB, TACAN). Radar vectors can provide course guidance and expedite traffic to the final approach course of any established IAP or to the traffic pattern for a visual approach.

### Bottom Briefing Strip (Communications Information)

The communications briefing strip contains communication information when available, in separate boxes, listed from left to right in the order that they would be used during arrival with the tower frequency box bolded:

ATIS <b>XXXXX</b>	APP CON <b>XXXX XXXX</b>	<b>TOWER</b> <b>XXXX XXXX</b>	GND CON <b>XXXXX</b>	CLNC DEL <b>XXXXX</b>	UNICOM <b>XXXXX</b>
----------------------	-----------------------------	----------------------------------	-------------------------	--------------------------	------------------------

- ATIS, AFIS (AK Only) or ASOS/AWOS frequencies (when available, ATIS or AFIS will be the only weather frequency/s published)
- the Approach Control (APP CON) name and frequencies; when the approach service is provided by other than Approach Control, e.g. FSS (Radio), Tower, Center, the appropriate air traffic facility call name is provided.
- the Control Tower (TWR) name and frequencies, to include Precision Radar Monitoring (PRM) and frequency
- Ground Control (GND CON) frequencies
- Clearance Delivery (CLNC DEL) frequencies; where a Control Tower does not exist or is part-time, a remoted CLNC DEL may be listed.
- Controller Pilot Data Link Communication (CPDLC)
- Ground Communications Outlet (GCO) frequency
- Common Traffic Advisory Frequency (CTAF), shown in parentheses when shares a frequency, e.g. UNICOM 122.8 (CTAF)
- UNICOM or AUNICOM frequency

Note: Part-time operations will be annotated with a star. Check Chart Supplement for times of operation.

# PLANVIEW

The planview of the IAP charts provides an overhead view of the entire instrument approach procedure.

The data on the planview is shown to scale, unless concentric rings, scale breaks or an inset have been used.

- Approach Segments
- NAVAIDs
- Restrictive Airspeeds
- Restrictive Altitudes
- Holding Patterns and Procedure Turns
- Airports
- Relief (Terrain Features)

- Hydrography
- International Boundary
- Obstacles (Man-made, Terrain and Vegetation)
- Special Use Airspace
- Minimum Safe Altitude
- Terminal Arrival Areas
- Helicopter (Copter) Procedures

## Approach Segments

The planview includes a graphical depiction of procedure entry through missed approach.

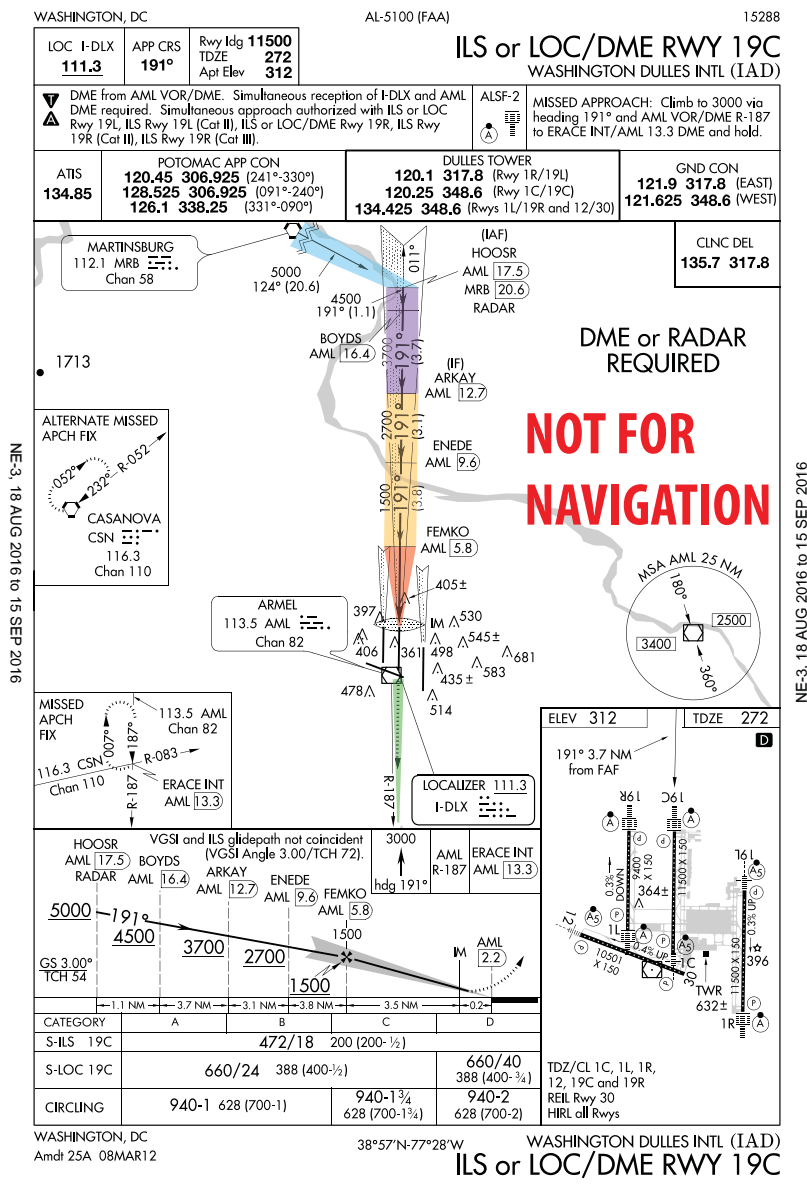

Sample IAP Example

Legend

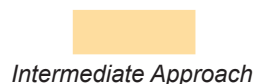
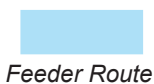

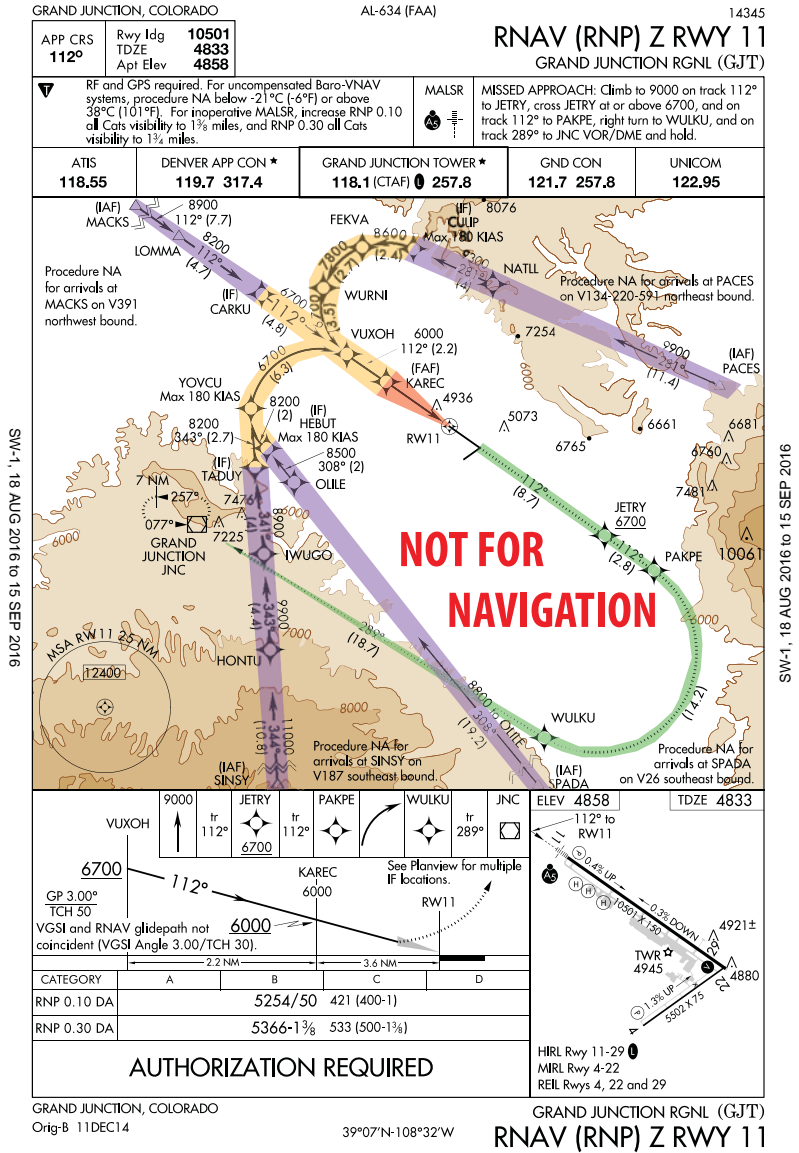

**Complex IAP Example with RF Legs**

- **Feeder Routes** (highlighted in blue - See Simple IAP Example on previous page) may be used to provide a transition from the enroute structure to the IAF.
- **Initial Approach** (highlighted in purple in examples above) is the segment between the initial approach fix (IAF) and the intermediate fix (IF) or the point where the aircraft is established on the intermediate course or final approach course.
- **Intermediate Approach** (highlighted in yellow in examples above) is the segment between the intermediate fix or point and the final approach fix.
- **Final Approach Course** (highlighted in red in the examples above) is the segment between the final approach fix or point and the runway, airport, or missed approach point.
- **Missed Approach** (highlighted in green in the example above) begins at the MAP and continues until the designated fix or waypoint. Missed Approach Procedure Track is shown as a hash marked line in the planview. If the missed approach fix falls outside of the area of the planview it will be shown in a separate box in the planview.



# NAVAIDS

NAVAIDs used on ground based charts will show the appropriate symbol accompanied by a data box that contains the facility name, frequency, identifier and Morse code. A NAVAID box with a heavy line indicates the primary NAVAID used for the approach.

NAVAIDs used on GPS based charts show the appropriate symbol identified with the name and identifier.

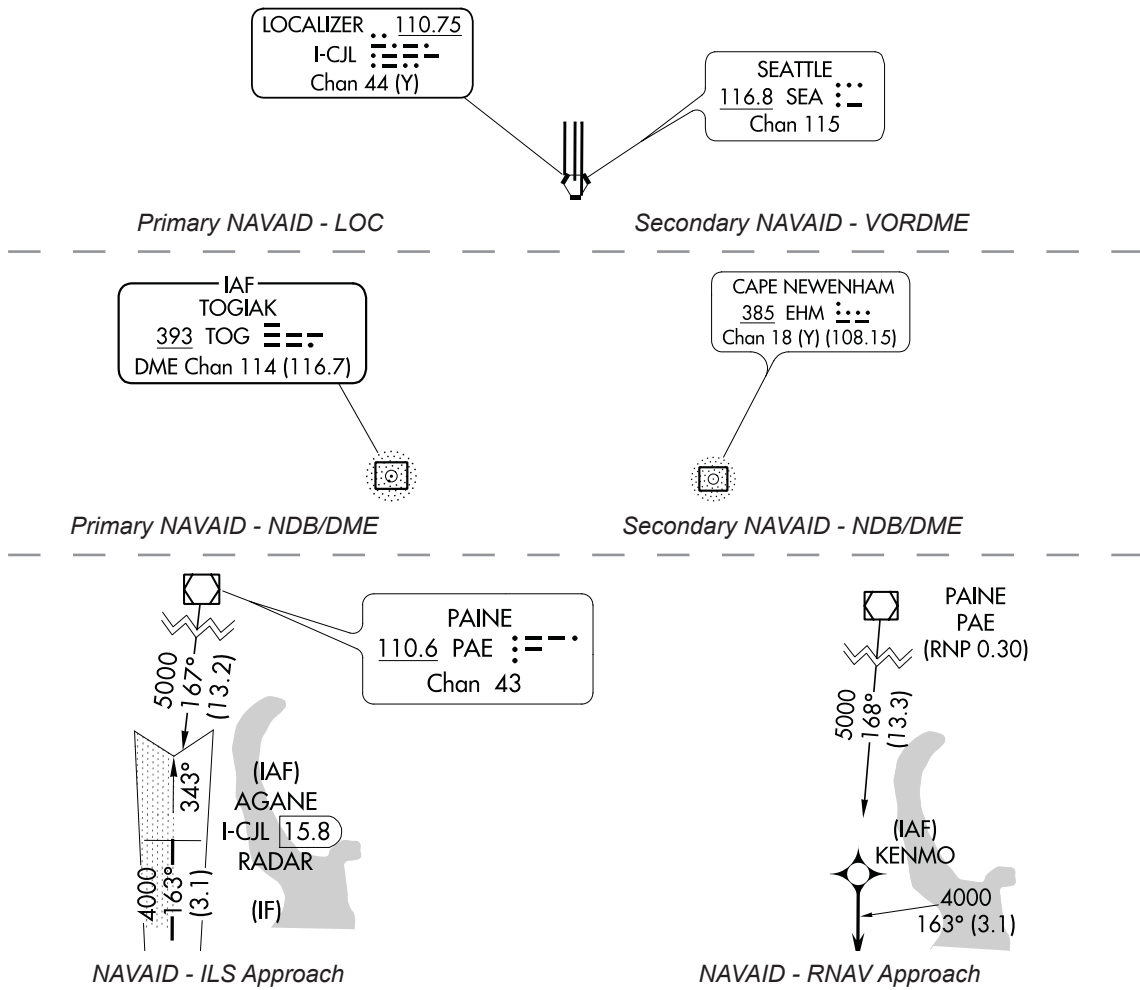

## Localizer Depiction

The localizer is depicted in the Planview using the following symbol. The size of the charted localizer symbol does not serve as an indication of the service volume.

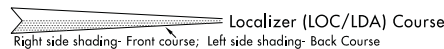

## Restrictive Airspeeds Along the Procedure Track

Restrictive airspeeds along the procedure track are shown paired with their respective fix/facility.

Type	Description	Example
Recommended Speed	Recommended speed is depicted with no lines above or below it	180K
Minimum Speed	Minimum speed is depicted as a number with a line below it	<u>120K</u>
Maximum Speed	Maximum speed is depicted as a number with a line above it	<u>250K</u>
Mandatory Speed	Mandatory speed is depicted as a number with a line above and below it	<u>175K</u>

## Altitudes

Restrictive altitudes along the procedure track are shown paired with their respective fix/ facility. Minimum, Maximum, Mandatory and Recommended Altitudes are shown.

Type	Description	Example
Recommended Altitude	Recommended altitude is depicted with no lines above or below it	3000
Minimum Altitude	Minimum altitude is depicted as a number with a line below it	<u>2500</u>
Maximum Altitude	Maximum altitude is depicted as a number with a line above it	<u>4300</u>
Mandatory Altitude	Mandatory altitude is depicted as a number with a line above and below it	<u>5500</u>
Mandatory Block Altitude	Mandatory block altitude is depicted with a minimum and a maximum altitude.	<u>5000</u> <u>3000</u>

Altitudes that are shown along a route are minimum altitudes.

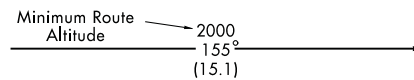

## Holding Patterns and Procedure Turns

Holding Patterns are used for many reasons, including deteriorating weather or high traffic volume. Holding might also be required following a missed approach. Each holding pattern has a fix, a direction to hold from the fix, and an airway, bearing, course, radial, or route on which the aircraft is to hold. These elements, along with the direction of the turns, define the holding pattern.



*Missed Approach*

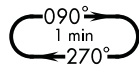

*Hold In-Lieu of Procedure Turn*

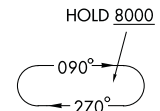
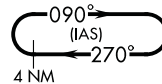

*Arrival*

If a holding pattern has a non-standard speed restriction, it will be depicted by an icon with the limiting air speed shown inside the holding pattern symbol. These elements, along with the direction of the turns, define the holding pattern. If two types of holds are located at the same point, the procedural holding pattern will be shown in-lieu of arrival or missed approach holding patterns. Timing or distance limits for Hold-in-lieu of Procedure Turn Holding Patterns will be shown.

Waypoints designated as a holding fix are shown as fly-by, without the circle around the symbol. However, in the event the holding fix/waypoint is also designated in some other part of the procedure (i.e., IAF) with a fly-over function, then the holding fix/waypoint will be charted as a fly-over point.

A procedure turn (PT) is the maneuver prescribed to perform a course reversal to establish the aircraft inbound on an intermediate or final approach course. The procedure turn or hold-in-lieu-of procedure turn is a required maneuver when it is depicted on the approach chart. However, the procedure turn or the hold-in-lieu-of PT is not permitted when the symbol "NoPT" is depicted on the initial segment being flown, when a RADAR VECTOR to the final approach course is provided, or when conducting a timed approach from a holding fix. The procedure turn will be shown in the planview and in the profile of the chart.

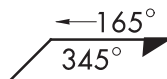

## Airports

The primary approach airport is shown to scale by a pattern of all the runways. Airports other than the primary approach airport may be shown with an airport pattern and name when in close proximity to the primary airport.

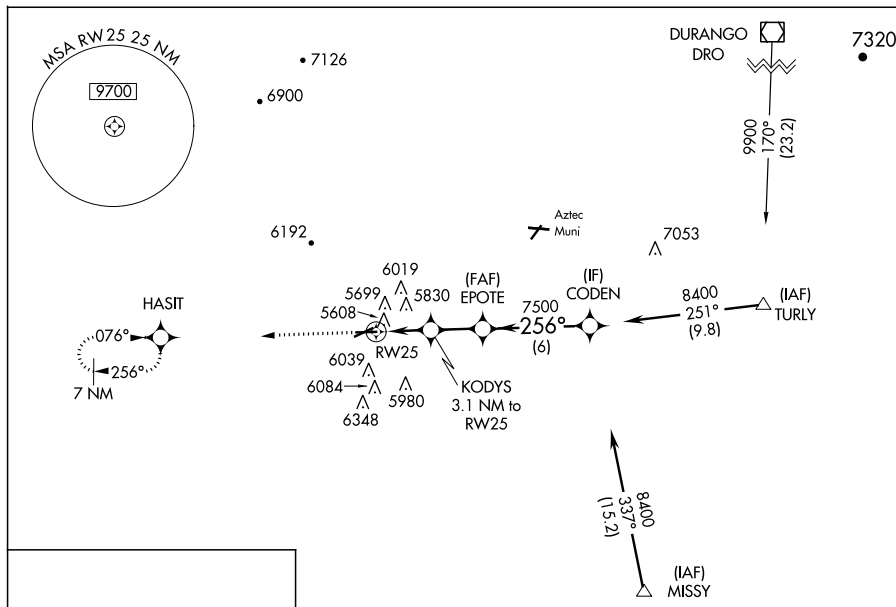

## Relief (Terrain Features)

Terrain is depicted in the planview portion of all IAPs at airports that meet the following criteria:

- If the terrain within the planview exceeds 4,000 feet above the airport elevation, or
- If the terrain within a 6.0 nautical mile radius of the Airport Reference Point (ARP) rises to at least 2,000 feet above the airport elevation.

When an airport meets either of the above criteria, terrain will be charted by use of contours, spot elevations, and gradient tints of brown on all IAPs for that airport. Contour layers will be shown in no more than five brown tints, with consecutively darker tints used for consecutively higher elevation contour layers.

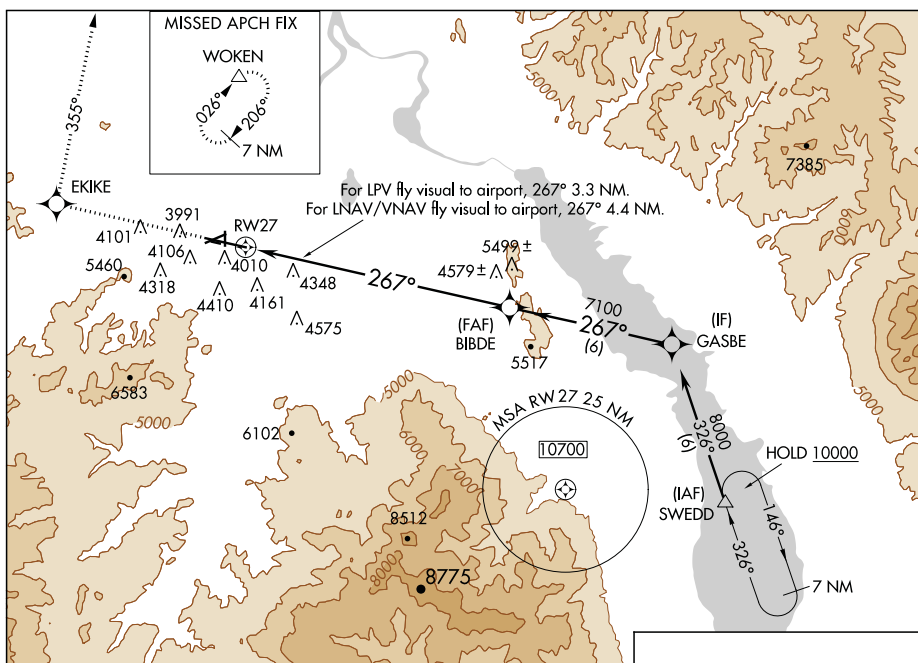



## Hydrography (Water)

Water Depiction is depicted in grey, in the planview portion of IAPs. See previous example. The following hydrographic features are shown:

- Oceans
- Significant rivers and streams
- Significant lakes - If only one river or one small lake is involved, not located in the immediate airport vicinity, the hydrographic information requirement may be waived.

## International Boundary

When the planview includes a boundary of another country the International boundaries are shown by a dashed line. International boundaries are identified with country name within the country area.

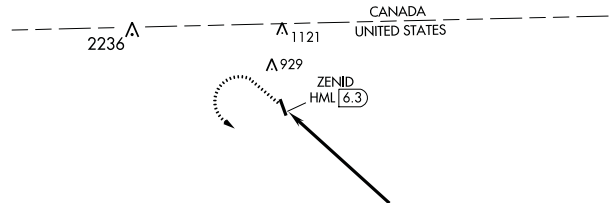

## Obstacles (Man-made, Terrain and Vegetation)

Obstacles are shown as  $\triangle$  when they are man-made or vegetation or as a  $\bullet$  when they are terrain. The highest obstacle, whether man-made or terrain is depicted with a bolder and larger symbol along with larger elevation font size. Any obstacle which penetrates a slope of 67:1 emanating from any point along the centerline of any runway shall be considered for charting within the area shown to scale. Obstacles specifically identified by the approving authority for charting shall be charted regardless of the 67:1 requirement.

Unverified obstacles shall be indicated by a doubtful accuracy symbol  $\pm$  following the elevation value.

On non-precision approaches, obstacles should be considered when determining where to begin descent from the MDA.

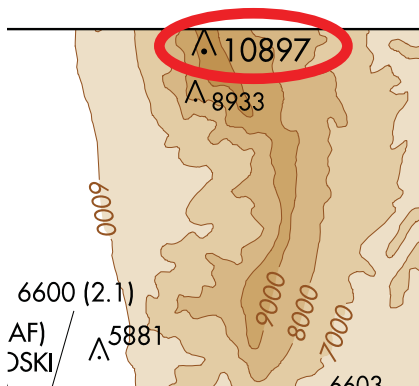

Highest Point - Obstacle

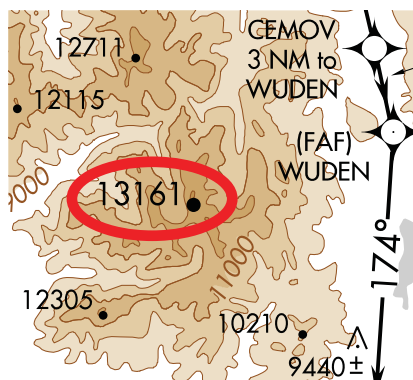

Highest Point - Terrain

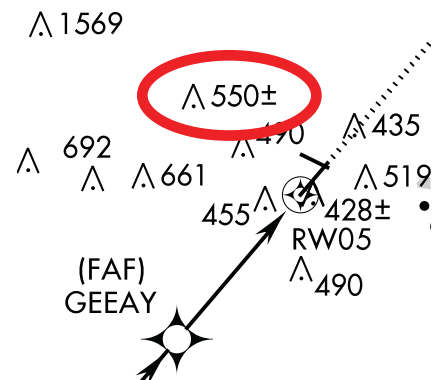

Unverified Obstacle - Obstacle

## Special Use Airspace (SUA)

SUAs consists of that airspace wherein activities must be confined because of their nature, or wherein limitations are imposed upon aircraft operations that are not a part of those activities, or both. These are prohibited areas, restricted areas, warning areas, Military Operations Areas (MOAs), and alert areas. SUA that falls within the area of coverage of the instrument approach procedure chart are shown only when designated by the approving authority.

## Air Defense Identification Zone (ADIZ)

ADIZ is an area of airspace in which the identification, location, and control of aircraft is required in the interest of national security. When designated by the approving authority, ADIZ boundaries that fall within the area of coverage of the chart are shown.

CONTIGUOUS U.S. ADIZ

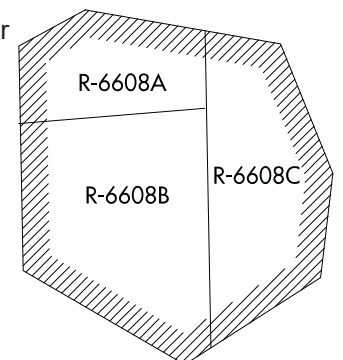

## Minimum Safe Altitude (MSA)

MSAs are published for emergency use on IAP charts. MSAs appear in the planview of all IAPs except on approaches for which a Terminal Arrival Area (TAA) is used. The MSA is based on the primary NAVAID, waypoint, or airport reference point on which the IAP is predicated. The MSA depiction on the approach chart contains the identifier of the NAVAID/waypoint/airport used to determine the MSA altitudes. MSAs are expressed in feet above mean sea level and normally have a 25 NM radius; however, this radius may be expanded to 30 NM if necessary to encompass the airport landing surfaces. Ideally, a single sector altitude is established and depicted on the planview of approach charts; however, when necessary to obtain relief from obstructions, the area may be further sectorized and as many as four MSAs established. When established, sectors may be no less than 90° in spread. MSAs provide 1,000 feet clearance over all obstructions but do not necessarily assure acceptable navigation signal coverage.

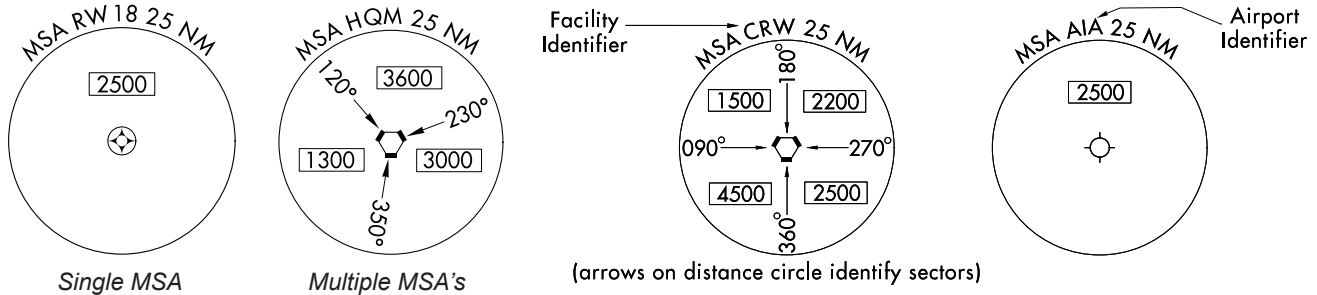

## Terminal Arrival Areas (TAAs)

The TAA icons will be positioned in the planview relative to their relationship to the procedure. The icon will not have feeder routes, airways, or radar vectors depicted. The TAA provides a transition from the enroute structure to the terminal environment with little required pilot/air traffic control interface for aircraft equipped with Area Navigation (RNAV) systems. A standard TAA has three areas: straight-in, left base, and right base. The arc boundaries of the three areas of the TAA are published portions of the approach. A TAA provides minimum altitudes with standard obstacle clearance when operating within the TAA boundaries. TAAs are primarily used on RNAV approaches but may be used on an ILS approach when RNAV is the sole means for navigation to the IF; however, they are not normally used in areas of heavy concentration of air traffic.

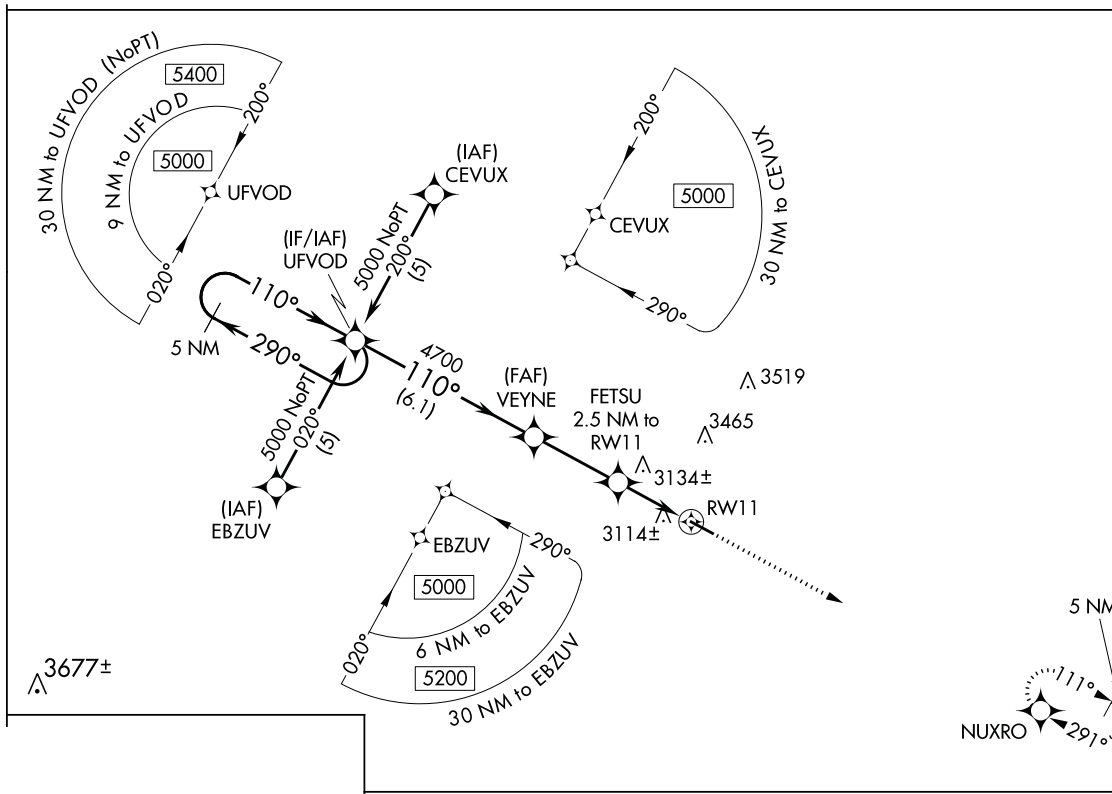

*Example of Standard TAA*

Non-standard TAAs may also be published; i.e., one base leg, no base legs.

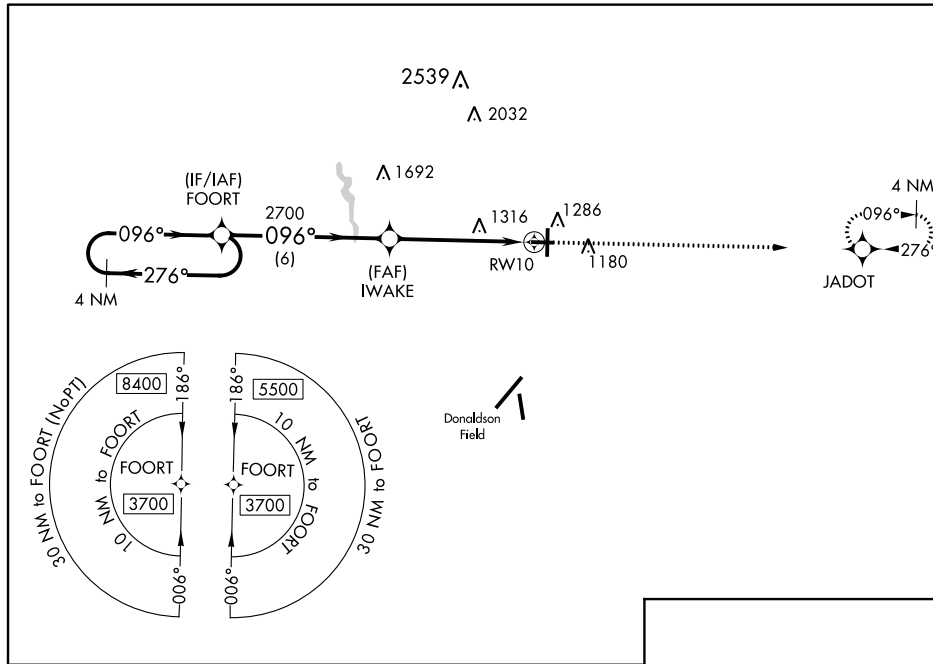

*Example of Non-Standard TAA*

**Helicopter (Copter) Procedures**

Copter procedures may contain either a visual or a VFR segment. Visual segments are depicted using the dashed line symbol below.



VFR Segments are not depicted with a line, but include the reference bearing and distance information at the endpoint of the VFR Segment, when provided, as shown below.

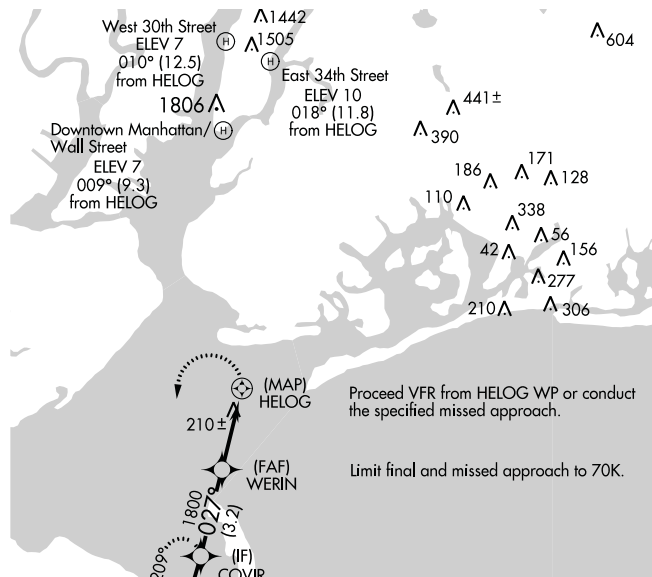

*Example of Copter with VFR Segment (JFK)*

When a visual flight path or VFR segment is required from the MAP to the heliport or alighting area, and as necessary for an explicit portrayal, an inset of the MAP area may be provided. This MAP area will depict significant landmark visual features. The procedure track, value and distance to the MAP and the visual segment and value to the landing point shall be shown within this inset. If it is a VFR segment, the reference bearing and distance text will be shown at the landing point.

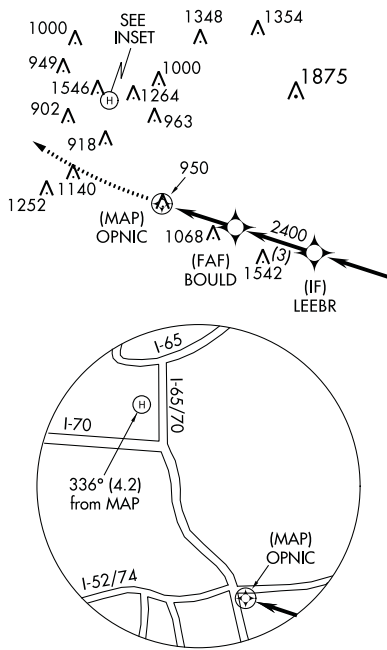

Example of Copter with Inset

### MISSED APPROACH INFORMATION

Missed approach information is shown in 3 locations on the chart:

- The Middle Briefing Strip - The complete textual missed approach instructions are provided at the top of the approach chart in the middle pilot briefing strip.
- The Planview - The missed approach track is drawn using a thin, hash marked line with a directional arrow. If the missed approach fix is off the chart, the missed approach track shall extend to the chart border.



- The Profile Box - Missed Approach Icons will be depicted in the upper left or upper right of the profile box. The Missed Approach Icons are intended to provide quick, at a glance intuitive guidance to the pilot, to supplement the textual missed approach instructions in the briefing strip. Space permitting, all textual missed approach instructions will be graphically depicted in sequence. If space does not permit the depiction of all missed approach icons, only the first four icon boxes will be shown.

Example Missed Approach Icons	Missed Approach Text				
<table border="1" style="width: 100%;"> <tr> <td style="text-align: center;">13000 ↑ RIL R-250</td> <td style="text-align: center;">TEKGU INT RIL 19</td> <td style="text-align: center;">EKR R-179</td> <td style="text-align: center;">WOKPA EKR 44.2</td> </tr> </table>	13000 ↑ RIL R-250	TEKGU INT RIL 19	EKR R-179	WOKPA EKR 44.2	MISSED APPROACH: Climb to 13000 on RIL VOR/DME R-250 to TEKGU INT/RIL 19 DME and on EKR VOR/DME R-179 to WOKPA/EKR 44.2 DME and hold, continue climb-in-hold to 13000.
13000 ↑ RIL R-250	TEKGU INT RIL 19	EKR R-179	WOKPA EKR 44.2		
<table border="1" style="width: 100%;"> <tr> <td style="text-align: center;">8000 ↙ SVC R-128</td> <td style="text-align: center;">Reverse Course</td> <td style="text-align: center;">SVC ☐</td> </tr> </table>	8000 ↙ SVC R-128	Reverse Course	SVC ☐	MISSED APPROACH: Climbing left turn to 8000 via SVC R-128, then reverse course to SVC VOR/DME and hold.	
8000 ↙ SVC R-128	Reverse Course	SVC ☐			

Example Missed Approach Icons	Missed Approach Text									
<table border="1"> <tr> <td>9000 ↑</td> <td>tr 112°</td> <td>JETRY 6700</td> <td>tr 112°</td> <td>PAKPE</td> <td>↷</td> <td>WULKU</td> <td>tr 289°</td> <td>JNC</td> </tr> </table>	9000 ↑	tr 112°	JETRY 6700	tr 112°	PAKPE	↷	WULKU	tr 289°	JNC	MISSED APPROACH: Climb to 9000 on track 112° to JETRY, cross JETRY at or above 6700, and on track 112° to PAKPE, right turn to WULKU, and on track 289° to JNC VOR/DME and hold.
9000 ↑	tr 112°	JETRY 6700	tr 112°	PAKPE	↷	WULKU	tr 289°	JNC		
<table border="1"> <tr> <td>14000 ↑ crs 174°</td> <td>HOMDU</td> <td>160° tr</td> <td>DEVEC</td> <td>160° tr</td> <td>FTI</td> </tr> </table>	14000 ↑ crs 174°	HOMDU	160° tr	DEVEC	160° tr	FTI	MISSED APPROACH: Climb to 14000 via 174° course to HOMDU and via 160° track to DEVEC and 160° track to FTI VORTAC and hold.			
14000 ↑ crs 174°	HOMDU	160° tr	DEVEC	160° tr	FTI					
<table border="1"> <tr> <td>5800 ↑</td> <td>10000 hdg 190°</td> <td>SVC R-193</td> <td>KUNRE</td> </tr> </table>	5800 ↑	10000 hdg 190°	SVC R-193	KUNRE	MISSED APPROACH: Climb to 5800, then climbing left turn to 10000 via heading 190° and SVC VOR/DME R-193 to KUNRE INT/SVC VOR/DME 24.1 DME and hold.					
5800 ↑	10000 hdg 190°	SVC R-193	KUNRE							

## PROFILE VIEW

A profile diagram of the instrument approach procedure is shown below the planview. The published descent profile and graphical depiction of the vertical path using those facilities, intersections, fixes, etc. identified in the procedure to the runway are shown. A profile view of the procedure track is shown. The approach track begins toward the top of the primary facility line, unless otherwise dictated by the procedure, and shall descend to where the final approach ends and the missed approach begins.

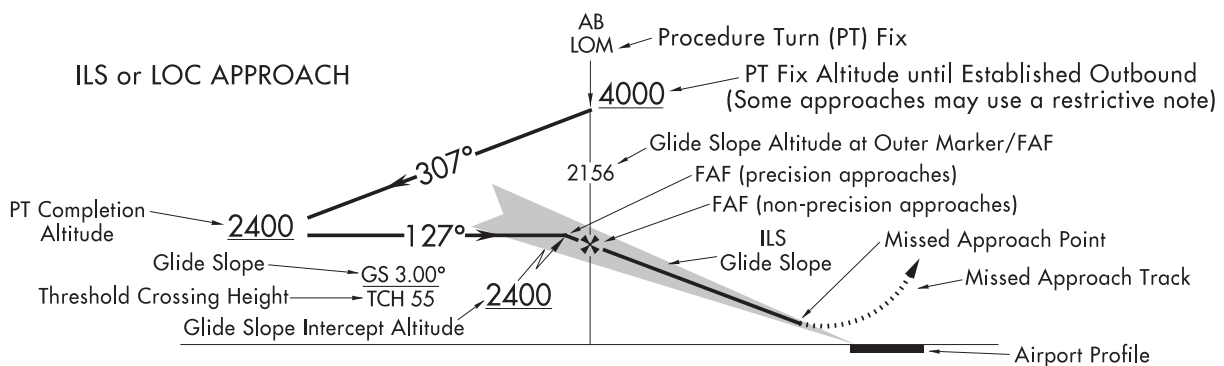

## RNAV and GLS PROCEDURES WITH VERTICAL GUIDANCE

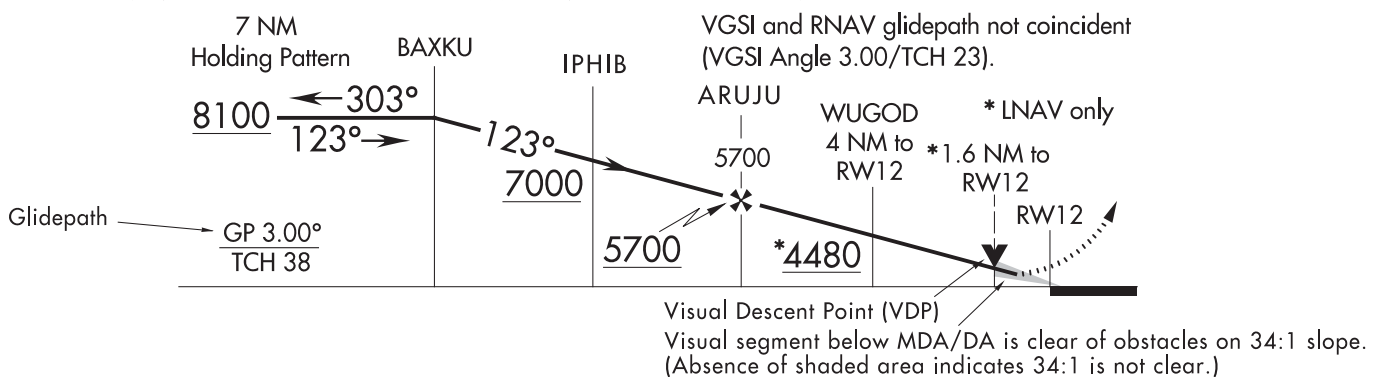

## Precision Approaches

On precision approaches, the glideslope (GS) intercept altitude is illustrated by a zigzag line and an altitude. This is the minimum altitude for GS interception after completion of the procedure turn. Precision approach profiles also depict the GS angle of descent, threshold crossing height (TCH) and GS altitude at the outer marker (OM) or designated fix.

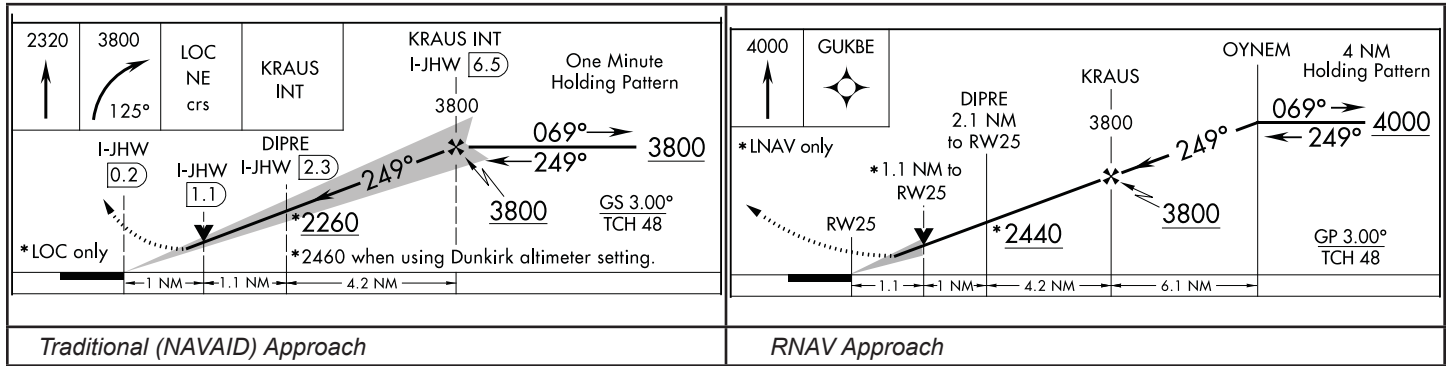

## Non-Precision Approaches

On nonprecision approaches, the final segment begins at the Final Approach Fix (FAF) which is identified with the Maltese cross symbol ✖. When no FAF is depicted, the final approach point is the point at which the aircraft is established inbound on the final approach course. Stepdown fixes may also be provided between the FAF and the airport for authorizing a lower minimum descent angle (MDA) and are depicted with the fix or facility name and a dashed line. On RNAV procedures without precision minima i.e., DAs, the approach track descends to the MDA or VDP point, thence horizontally to the missed approach point. On non-RNAV procedures without precision minima, the horizontal segment is shown from the VDP, when it exists, or the MDA when there is no VDP, and a vertical glide angle/TCH is provided.

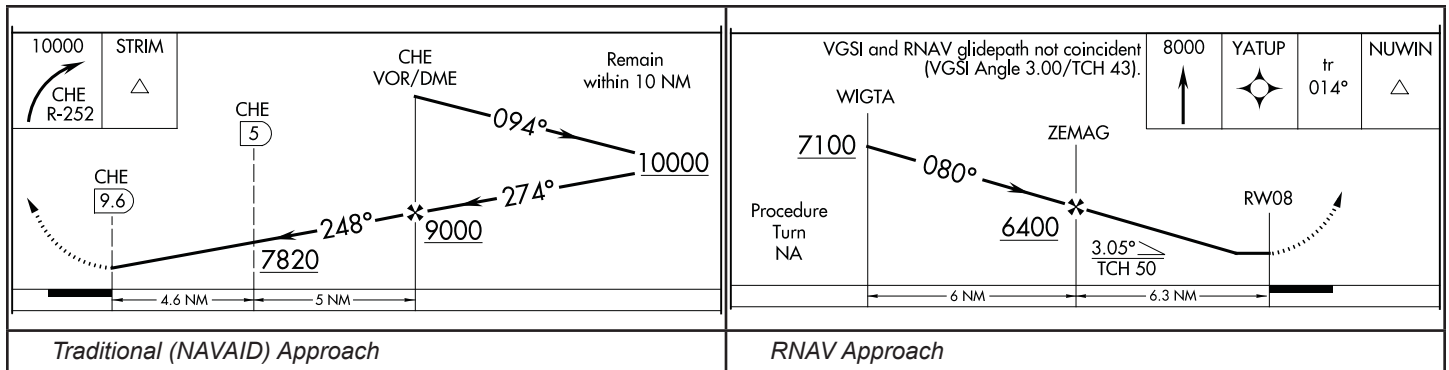

## Visual Descent Point (VDP)

The Visual Descent Point (VDP), is shown by a bold letter "V" positioned above the procedure track and centered on the accompanying dashed line. (See example below.) The VDP is a defined point on the final approach course of a non-precision straight-in approach procedure from which normal descent from the MDA to the runway touchdown point may be commenced.

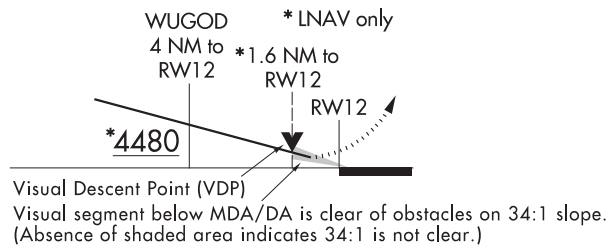

## Vertical Descent Angle (VDA) and Threshold Crossing Heights (TCH)

A VDA and TCH may be published on non-precision approaches. For Copter approach procedures, a Heliport Crossing Height (HCH) will be depicted in place of the TCH. The VDA is strictly advisory and provides a means to establish a stabilized descent to the MDA. The presence of a VDA does not guarantee obstacle protection in the visual segment. If there are obstacles in the visual segment that could cause an aircraft to destabilize the approach between MDA and touchdown, the profile will not show a VDA and will instead show a note that states either “Descent Angle NA” or “Descent Angle NA-Obstacles”.

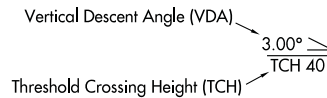

## Visual Flight Path

Instrument approach procedures, including Copter approach procedures, that terminate or have missed approaches prior to the airport, and are authorized to proceed visual, shall depict the visual segment by the dashed line symbol from the missed approach point to the airport. The note “Fly visual” (“Proceed visually” on Copter procedures) along with the bearing and distance shall be shown leadered to the visual flight path.

RNAV charts sometimes have visual flight for LNAV/VNAV minima which do not start at the missed approach point. An additional note indicating “LNAV/VNAV” will be placed above the note.

Copter approach procedures with a VFR segment from the missed approach point will not depict the VFR segment with a line in the profile. The note similar to “Proceed VFR from MAP” will be shown.

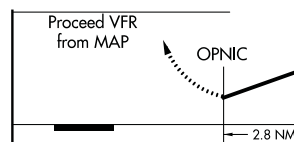

Copter VFR Segment

## Chart Examples

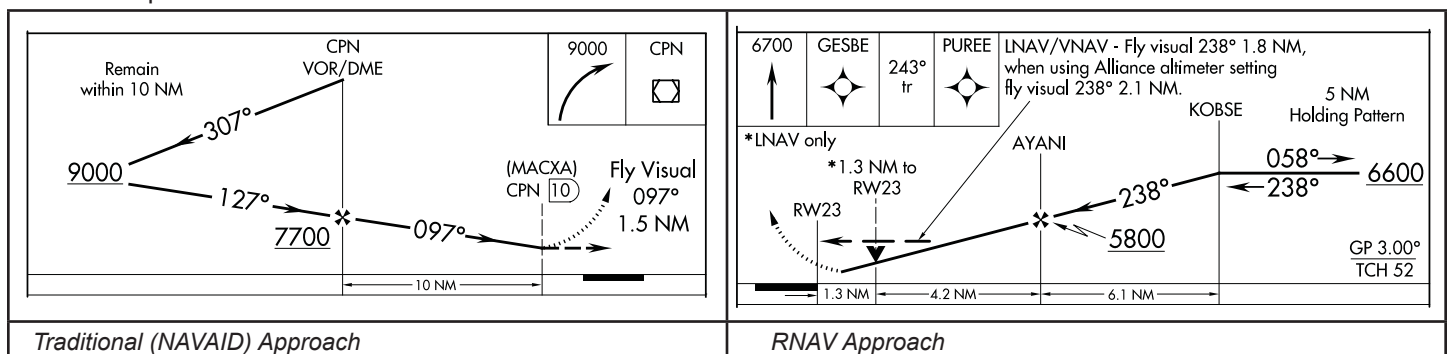

## ILS Glide Slope and RNAV Glidepath

A note providing the glide slope (GS) or glidepath (GP) angle and the threshold crossing height (TCH), are positioned in the lower half of the profile box

- GS will be shown on all ILS procedures.
- GP will be shown GLS procedures and all RNAV procedures with a published altitude

Threshold Crossing Height (TCH) has been traditionally used in “precision” approaches as the height of the glide slope above threshold. With publication of LNAV/VNAV minimums and RNAV descent angles, including graphically depicted descent profiles, TCH also applies to the height of the “descent angle,” or glidepath, at the threshold.

### 34:1 Surface Clear Stipple Symbol

On RNAV approach charts, a small shaded arrowhead shaped symbol from the end of the VDA to the runway indicates that the 34:1 Obstacle Clearance Surface (OCS) for the visual segments is clear of obstacles. (See example in VDP Section.)

## LANDING MINIMUMS

The landing minimums section is positioned directly below the profile. This section gives the pilot the lowest altitude and visibility requirements for the approach. There are two types of landing minimums: Straight-in landing or Circling. Straight-in landing minimums are the MDA and visibility, or DH and visibility, required for a straight-in landing on a specified runway. Circling minimums are the MDA and visibility required for the circle-to-land maneuver.

The minimums for straight-in and circling are located under each aircraft category. When there is not a division line between minimums for each category, the minimums apply to two or more categories.

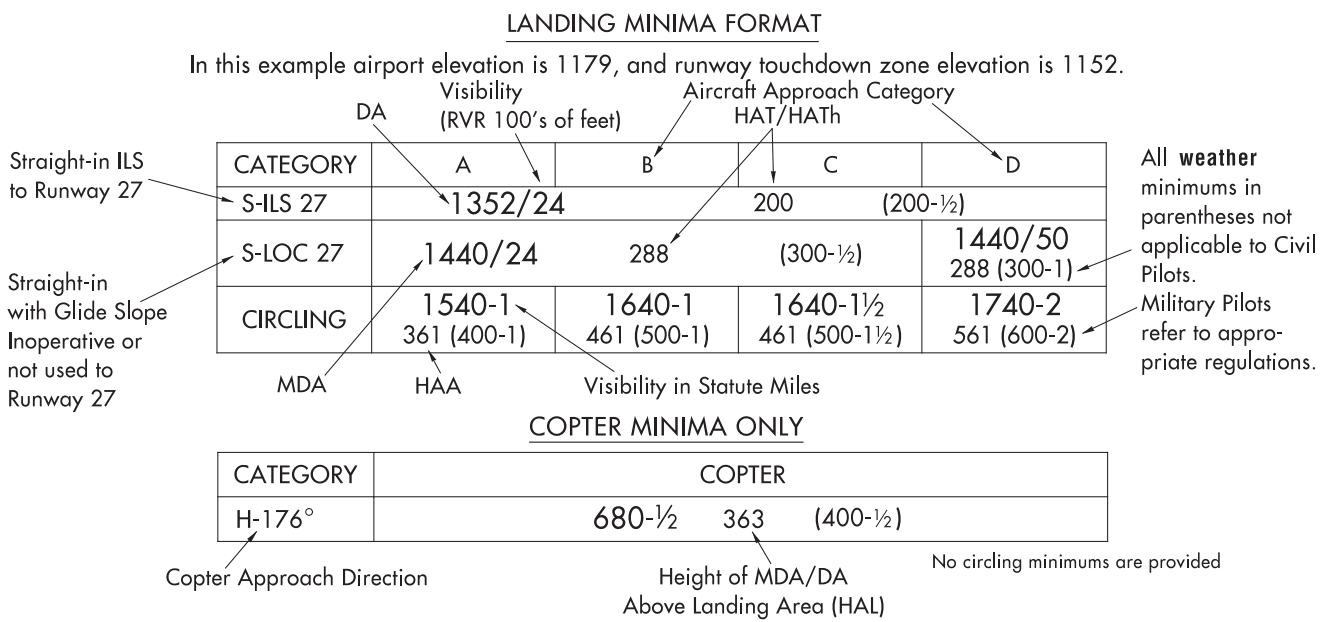

A second category of straight-in minimums called "sidestep" may be depicted where parallel runways exist.

CATEGORY	A	B	C	D
S-ILS 24R	320/18		200	(200-½)
S-LOC 24R	460/24	340 (400-½)	460/40 340 (400-¾)	
SIDESTEP RWY 24L	580/50	459 (500-1)	580-1½ 459 (500-1½)	

The terms used to describe the minimum approach altitudes differ between precision and nonprecision approaches. Precision approaches use DH, which is referenced to the height above touchdown elevation (HAT). Nonprecision approaches use MDA, referenced to "feet MSL." The MDA is also referenced to HAT for straight-in approaches, or height above airport (HAA) for circling approaches. The figures listed parenthetically are for military operations and are not used in civil aviation.



The visibility values are shown after the DA/DH or MDA. They are provided in statute miles or runway visual range (RVR). RVR is reported in hundreds of feet. If the visibility is in statute miles, there is an altitude number, hyphen, whole or fractional number, e.g. 530-1. This indicates 530 feet MSL and 1 statute mile of visibility. The RVR value is separated from the minimum altitude with a slash, e.g., 1540/24. This indicates 1540 feet MSL and RVR of 2400 feet. When an RVR value is shown, the comparable statute mile equivalent is shown within the military minimums in parentheses as shown in the examples above. This value is determined from the Comparable Values of RVR and Visibility table located in the TPP Legend.

Comparable Values of RVR and Visibility

The following table shall be used for converting RVR to ground or flight visibility. For converting RVR values that fall between listed values, use the next higher RVR value; do not interpolate. For example, when converting 4800 RVR, use 5000 RVR with the resultant visibility of 1 mile.

RVR (feet)	Visibility (SM)	RVR (feet)	Visibility (SM)	RVR (feet)	Visibility (SM)	RVR (feet)	Visibility (SM)
1600	¼	2400	½	3500	¾	5500	1
1800	½	2600	½	4000	¾	6000	1¼
2000	½	3000	¾	4500	¾		
2200	½	3200	¾	5000	1		

When a reference mark (\*, \*\*, #, etc.) is shown on a line of minimums, the qualifying footnote is provided in the notes section.

FALMOUTH, MASSACHUSETTS AL-10362 (FAA) 17061

LOC/DME I-BNX <b>110.75</b> Chan <b>44</b> (Y)	APP CRS <b>322°</b>	Rwy Idg TDZE <b>116</b> Apt Elev <b>130</b>	<b>9501</b>	<b>ILS or LOC RWY 32</b>			
Circling NA northeast of Rwy 14 and northwest of Rwy 23. <b>*RVR 1800 authorized with use of FD or AP or HUD to DA.</b>				MALSR 	MISSED APPROACH: Climb to 1400 then climbing left turn to 2000 on heading 112° and I-BNX localizer SE course to HAGTU INT/I-BNX 6.6 DME and hold.		CAPE COD COAST GUARD AIR STATION (F'MH)
ATIS <b>120.475 236.825</b>		CAPE APP CON * <b>284.6</b>		COAST GUARD TOWER <b>128.425</b>		GND CON <b>124.15 275.8</b>	

ELEV 130	TDZE 116						
		1400 hdg 112°	2000 I-BNX SE crs	HAGTU INT	HAGTU INT I-BNX <u>6.6</u> MVY <u>15</u>	One Minute Holding Pattern	
REIL Rwy 5 and 14 HIRL Rwy 5-23 and 14-32 FAF to MAP 4.2 NM				1700 1700 1700		GS 3.00° TCH 50	
Knots: 60 90 120 150 180 Min:Sec: 4:12 2:48 2:06 1:41 1:24		CATEGORY A	CATEGORY B	CATEGORY C	CATEGORY D		
FALMOUTH, MASSACHUSETTS Amdt 1B 21JUL16		CAPE COD COAST GUARD AIR STATION (F'MH) 41°40'N-70°31'W		<b>ILS or LOC RWY 32</b>			

## Circling Minimums

There was a change to the TERPS criteria in 2012 that affects circling area dimension by expanding the areas to provide improved obstacle protection. To indicate that the new criteria had been applied to a given procedure, a **C** is placed on the circling line of minimums. The new circling tables and explanatory information is located in the Legend of the TPP.

The approaches using standard circling approach areas can be identified by the absence of the **C** on the circling line of minima.

CATEGORY	A	B	C	D
LPV DA	308/24 200 (200-½)			
LNAV/VNAV DA	804-2 696 (700-2)			
LNAV MDA	800/24 692 (700-½)		800-1½ 692 (700-1½)	
CIRCLING	800-1 687 (700-1)		800-2 860-2½ 687 (700-2) 747 (800-2½)	

*Apply Standard Circling Approach Maneuvering Radius Table*

CATEGORY	A	B	C	D
<b>C</b> CIRCLING	9120-1¼ 1709 (1800-1¼)	9120-1½ 1709 (1800-1½)	9260-3 1849 (1900-3)	NA

*Apply Expanded Circling Approach Maneuvering Airspace Radius Table*

## AIRPORT SKETCH

The airport sketch is a depiction of the airport with emphasis on runway pattern and related information, positioned in either the lower left or lower right corner of the chart to aid pilot recognition of the airport from the air and to provide some information to aid on ground navigation of the airport. The runways are drawn to scale and oriented to true north. Runway dimensions (length and width) are shown for all active runways.

Runway(s) are depicted based on what type and construction of the runway.

Hard Surface	Other Than Hard Surface	Metal Surface	Closed Runway	Under Construction
Stopways, Taxiways, Parking Areas	Displaced Threshold	Closed Pavement	Water Runway	

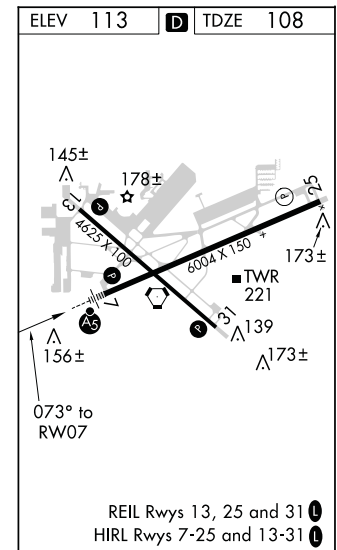

Taxiways and aprons are shaded grey. Other runway features that may be shown are runway numbers, runway dimensions, runway slope, arresting gear, and displaced threshold.

Other information concerning lighting, final approach bearings, airport beacon, obstacles, control tower, NAVAIDs, helipads may also be shown.

## Airport Elevation and Touchdown Zone Elevation

The airport elevation is shown enclosed within a box in the upper left corner of the sketch box and the touchdown zone elevation (TDZE) is shown in the upper right corner of the sketch box. The airport elevation is the highest point of an airport's usable runways measured in feet from mean sea level. The TDZE is the highest elevation in the first 3,000 feet of the landing surface. Circling only approaches will not show a TDZE.

## Runway Declared Distance Information

Runway declared distance information when available will be indicated by **D** and is shown to the right of the airport elevation in the sketch box. Declared distances for a runway represent the maximum distances available and suitable for meeting takeoff and landing distance performance requirements.

## Runway Lights

Notes regarding approach lighting systems are shown at the bottom of the sketch box. Runway lights (HIRL) (MIRL) (LIRL) (TDZL)(TDZ/CL) shall be indicated by a note, e.g. HIRL Rwy 9-27.

Other approach lighting is shown on the airport sketch as a symbol on the side of the runway where they are actually located. Symbols that are shown in negative indicate pilot-controlled lighting.

Runway centerline lights (CL) are installed on some precision approach runways to facilitate landing under adverse visibility conditions. They are located along the runway centerline and are spaced at 50 foot intervals. Runways with CL are shown in a negative dot pattern through the middle of the solid runway as illustrated in the airport sketch to right.

Runway centerline lights will be indicated by a note only when paired with TDZL, e.g., TDZ/CL Rwys 6 and 24.

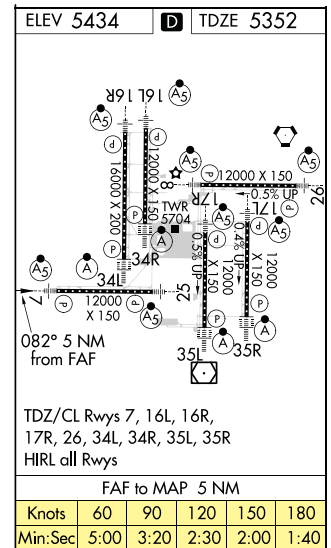

## Time/Distance Table

When applicable, a Time/Distance Table is provided below the airport sketch. The table provides the distance and time that is required from the final approach fix to the missed approach point for select groundspeeds.

## Base Information (Copter Approaches Only)

Base Information, as required and necessary to identify the MAP area and in the vicinity of the landing area shall be provided. Information shall be limited to and depict significant visual landmark features at and surrounding the MAP area and the heliport/pad of intended landing.

## AIRPORT DIAGRAMS

Airport Diagrams are specifically designed to assist in the movement of ground traffic at locations with complex runway/taxiway configurations. Airport Diagrams are not intended for use in approach and landing or departure operations. An airport diagram assists pilots in identifying their location on the airport, thus reducing requests for “progressive taxi instructions” from controllers.

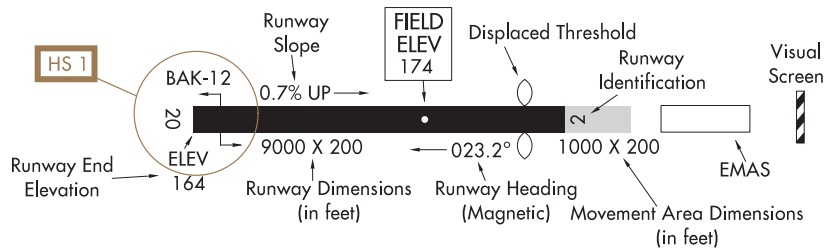

## Airport Diagram Features:





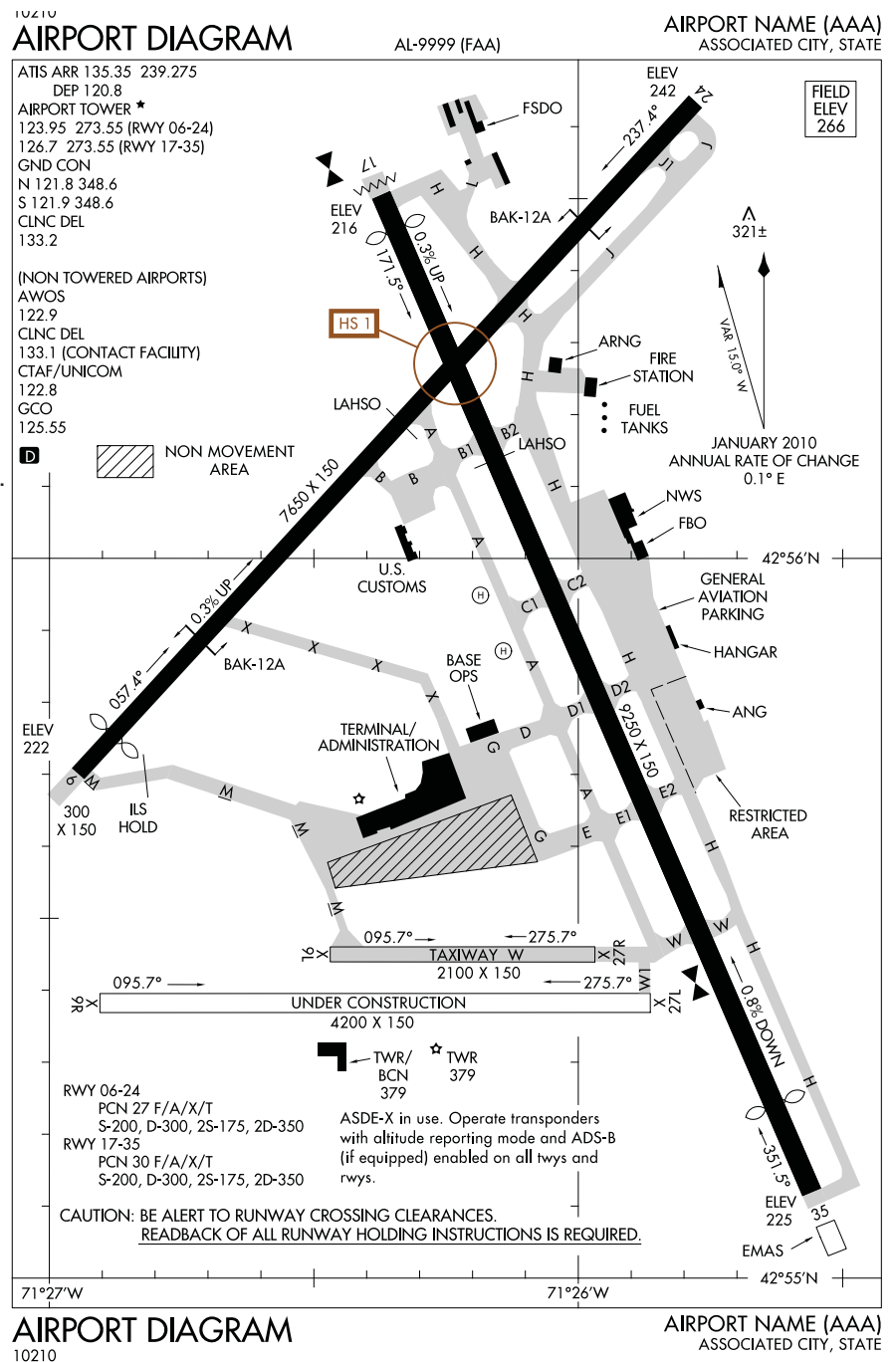



1. Runways
  - a. complete with magnetic headings (including magnetic variation and epoch year) and identifiers.
  - b. Runways under construction shall also be shown.
  - c. Runway dimensions, displaced thresholds, runway end elevations.
  - d. Runway surface composition
  - e. Weight bearing capacity (landing gear configuration or Pavement Classification Number)
  - f. Land and Hold Short (LAHSO) lines, ILS hold lines, Localizer/Glide Slope Critical Areas.
  - g. Arresting Gear. To include Engineered Materials Arresting System (EMAS).
2. Taxiways, with identifiers. Taxiways under construction shall also be shown.
3. Hot Spot locations.
4. Parking areas, run-up pads, alert areas, landing pads, "Non-Movement" areas (where pilot is NOT under air traffic control), ramps, aprons and hold pads.
5. Turnarounds, blast pads, stopways, overruns, and clearways (include dimensions when known).
6. Large tanks, including fueling area.
7. Control towers (include tower height).
8. Airport beacon.
9. Helicopter pads.
10. Radar reflectors.
11. Highest obstruction within diagram boundary.
12. Any building that pilot can taxi to. Other buildings to include terminal/administration and Base operations, fire station, NWS, AFSS, FAA, FSDO, ANG, USCG, FBO.
13. Comm Frequencies.

Note: Star when used in the Comm Frequencies indicates part-time status. Check Chart Supplement for times of operation.



## Runway Construction

Runway construction is depicted as follows:

Hard Surface	Other Than Hard Surface	Metal Surface	Closed Runway	Under Construction
				
Stopways, Taxiways, Parking Areas	Displaced Threshold	Closed Pavement	Water Runway	
				

## Hot Spots

Hot Spots (HS) are a runway safety related problem area or intersection on an airport. Typically it is a complex or confusing taxiway/taxiway or taxiway/runway intersection. A confusing condition may be compounded by a miscommunication between a controller and a pilot, and may cause an aircraft separation standard to be compromised. The area may have a history of surface incidents or the potential for surface incidents.

Hot Spots are indicated on the Airport Diagram with a brown open circle or polygon leadered to a Hot Spot number, e.g., HS 1. The number corresponds to a listing and description on the Hot Spot page in the front the TPP. More information and location of Hot Spots can be found at [http://www.faa.gov/airports/runway\\_safety/hotspots/hotspots\\_list/](http://www.faa.gov/airports/runway_safety/hotspots/hotspots_list/).

## DEPARTURE PROCEDURES (DPs)

Departure Procedures (DPs) are designed specifically to assist pilots in avoiding obstacles during the climb to the minimum enroute altitude, and/or airports that have civil IFR takeoff minimums other than standard. There are two types of DPs: Obstacle Departure Procedures (ODPs), printed either textually or graphically and Standard Instrument Departures (SIDs), always printed graphically. SIDs are primarily designed for system enhancement and to reduce pilot/controller workload, and require ATC clearance. ODPs provide obstruction clearance via the least onerous route from the terminal area and may be flown without ATC clearance. All DPs provide the pilot with a safe departure from the airport and transition to the enroute structure.

Generally, DP charts are depicted “not to scale” due to the great distances involved on some procedures or route segments. A “to scale” portrayal may be used if readability is assured.

The DP will show the departure routing, including transitions to the appropriate enroute structure. All routes, turns, altitudes, NAVAIDs, facilities forming intersections and fixes, and those facilities terminating the departure route are shown. A textual description of the departure procedure is also provided. For RNAV DPs, the transition text consists of the transition name and associated computer code. On non-RNAV DPs, the transition text will also include the description of all turns, altitudes, radials, bearings and facilities/fixes needed to guide the user from the common departure point to the terminating facility fix.

Copter DPs may also include a visual or VFR segment. Visual segments are depicted using the dashed line symbol below.



VFR Segments are not depicted with a line, but include the reference bearing and distance information at the endpoint of the VFR Segment, when provided, as shown below.

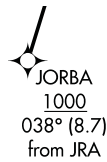

(H)

Example of Copter with VFR Segment

## STANDARD TERMINAL ARRIVAL (STARs) CHARTS

STARs are pre-planned Instrument Flight Rule (IFR) air traffic control arrival procedures for pilot use in graphic and/or textual form. STARs depict prescribed routes to transition the aircraft from the enroute structure to a fix in the terminal area from which an instrument approach can be conducted. STARs reduce pilot/controller workload and air-ground communications, minimizing error potential in delivery and receipt of clearances.

STAR charts generally shall be depicted 'not to scale' due to the great distances involved on many procedures and route segments. A 'to scale' depiction may be used only if readability is assured.

The STAR will show the arrival routing, including transitions from the appropriate enroute structure. All routes, turns, altitudes, NAVAIDs, facilities forming intersections and fixes, and those facilities/fixes terminating or beginning the arrival route shall be shown in the graphic depiction. A textual description of the arrival procedure is also provided. For RNAV STARs, transition text will consist of the transition name and associated computer code. For non-RNAV STARs, the transition text will also include a description of all turns, altitudes, radials, bearings and facilities/fixes needed to guide the user from the entry point to the common facility/fix.

## CHARTED VISUAL FLIGHT PROCEDURE (CVFP) CHARTS

CVFPs are charted visual approaches established for environmental/noise considerations, and/or when necessary for the safety and efficiency of air traffic operations. The approach charts depict prominent landmarks, courses, and recommended altitudes to specific runways. CVFPs are designed to be used primarily for turbojet aircraft. CVFPs are not instrument approaches and do not have missed approach segments.

CVFPs are named for the primary landmark and the specific runway for which the procedure is developed, such as: RIVER VISUAL RWY 18, STADIUM VISUAL RWY 24. The CVFP charts are divided into planview and notes sections separated by a bar scale in 1 NM increments. The planview of the CVFP includes the portrayal of visual approach procedures information, such as landmarks, NAVAIDs, visual track, hydrography, special use airspace and cultural features, as applicable.

CVFPs originate at or near, and are designed around, prominent visual landmarks and typically do not extend beyond 15 flight path miles from the landing runway. Visual tracks start at a geographical point or landmark where the procedure must be flown visually to the airport. The visual track is indicated by a dashed line. Visual tracks may include the track value, distance and minimum or recommended altitudes.

# U.S. TERMINAL PROCEDURES PUBLICATION SYMBOLS

## GENERAL INFORMATION

Symbols shown are for the Terminal Procedures Publication (TPP) which includes Standard Terminal Arrival (STARs) Charts, Departure Procedures (DPs), Instrument Approach Procedures (IAP) and Airport Diagrams.

## LEGEND - STANDARD TERMINAL ARRIVAL (STAR) CHARTS - DEPARTURE PROCEDURE (DP) CHARTS

LEGEND 19059

### LEGEND

#### STANDARD TERMINAL ARRIVAL (STAR) CHARTS DEPARTURE PROCEDURE (DP) CHARTS

Applies to both STAR and DP Charts unless otherwise noted.

<h4>RADIO AIDS TO NAVIGATION</h4> <p><b>Compulsory:</b></p> <p>  VOR                 VORTAC                 DME                 NDB/DME   VOR/DME                 TACAN                 NDB         </p> <p><b>Non-Compulsory:</b></p> <p>  VOR                 VORTAC                 DME   VOR/DME                 TACAN                 NDB                 NDB/DME         </p> <p>  LMM, LOM (Compass locator)   Marker Beacon         </p> <p>  LOC                 LOC/DME  <small>(shown when installation is offset from its normal position off the end of the runway.) (DP)</small> </p> <p>  Localizer Course   SDF Course         </p>	<h4>ROUTES</h4> <p>             4500 MEA-Minimum Enroute Altitude              *3500 MOCA-Minimum Obstruction Clearance Altitude   270° Departure Route - Arrival Route              (65) Mileage between Radio Aids, Reporting Points, and Route Breaks         </p> <p>  Transition Route   R-275 Radial line and value   Lost Communications Track   Visual Flight Path (DP)         </p> <p>  [V12] [J80] Airway/Jet Route Identification         </p> <p>  DP Holding Pattern (IAS)   STAR Holding Pattern (IAS)         </p> <p>             Holding pattern with max. restricted airspeed (175K) applies to all altitudes (210K) applies to altitudes above 6000' and including 14000'         </p>
<p>(T) indicates frequency protection range (STAR)</p> <p>Identifier: ORLANDO</p> <p>Frequency: 112.25 (T) ORL Chan 59 (Y)</p> <p>Geographic Position: N28°32.56' W81°20.10'</p> <p>Underline indicates no voice transmitted on this frequency</p> <p>Coordinates: N38°58.30' W89°51.50'</p> <p>Frequency: 112.7 CAP</p> <p>Identifier: PRAYS</p> <p>Waypoint Name: PRAYS</p> <p>Reference Facility Elevation: 590</p> <p>Radial-Distance (Facility to Waypoint): 187.1°-56.2'</p>	<h4>SPECIAL USE AIRSPACE</h4> <p>  R-352 R-Restricted   W-Warning   P-Prohibited   A-Alert   MOA-Military Operations Area         </p> <h4>ALTITUDES</h4> <p>             5500 Mandatory Altitude (Cross at)              2300 Minimum Altitude (Cross at or above)              4800 Maximum Altitude (Cross at or below)         </p> <p>  Altitude change at other than Radio Aids (STAR)         </p> <p>             15000 Block Altitude              12000         </p> <h4>INDICATED AIRSPEED</h4> <p>             175K Mandatory Airspeed              120K Minimum Airspeed              250K Maximum Airspeed         </p>
<h4>FIXES/ATC REPORTING REQUIREMENTS</h4> <p>             Reporting Points              N00°00.00' W00°00.00'         </p> <p>  (75) DME Mileage (when not obvious)         </p> <p>             ▲ Fix-Compulsory and              △ Non-Compulsory Position Report         </p> <p>  DME fix   WAYPOINT (Compulsory)   WAYPOINT (Non-Compulsory)         </p> <p>  FLYOVER POINT         </p> <p>             X Computer Navigation Fix (CNF) - No ATC Function              N00°00.00' W00°00.00'         </p>	<h4>AIRPORTS</h4> <p>             (DP)      Heliport              Joint Civil-Military         </p> <p>             Airports not served by the procedure shown in screened color (STAR)         </p> <p>  Civil  Military  Joint Civil-Military         </p> <h4>MISCELLANEOUS</h4> <p>  Changeover Point   Distance not to scale (DP)   International Boundary (DP)   Air Defense Identification Zone   Takeoff Minimums and (Obstacle) Departure Procedures entry published. (DP)         </p>

21 MAY 2020 to 18 JUN 2020

21 MAY 2020 to 18 JUN 2020

FAA Chart Users' Guide - Terminal Procedures Publication (TPP) - Symbols

LEGEND 19059

# APPROACH LIGHTING SYSTEM

LEGEND 15344

INSTRUMENT APPROACH PROCEDURES (CHARTS)  
APPROACH LIGHTING SYSTEM - UNITED STATES

Approach lighting and visual glide slope systems are indicated on the airport sketch by an identifier, e.g., (A2), (V), etc.

A dot "•" portrayed with approach lighting letter identifier indicates sequenced flashing lights (F) installed with the approach lighting system e.g., (A1). Negative symbology, e.g., (A5), (V) indicates Pilot Controlled Lighting (PCL).

## RUNWAY TOUCHDOWN ZONE AND CENTERLINE LIGHTING SYSTEMS

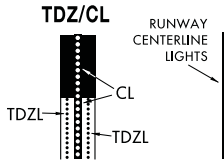

AVAILABILITY of TDZ/CL will be shown by NOTE in SKETCH e.g. "TDZ/CL Rwy 15"

## APPROACH LIGHTING SYSTEM

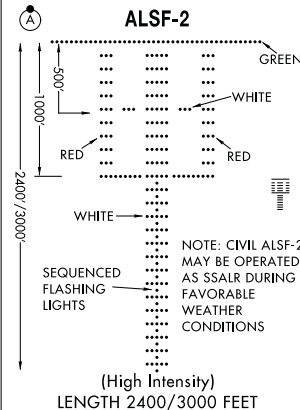

## APPROACH LIGHTING SYSTEM

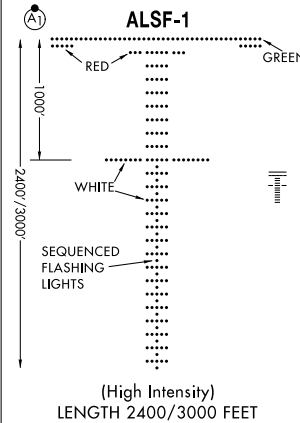

## SHORT APPROACH LIGHTING SYSTEM

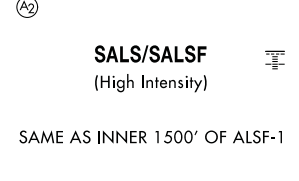

## SIMPLIFIED SHORT APPROACH LIGHTING SYSTEM with Runway Alignment Indicator Lights

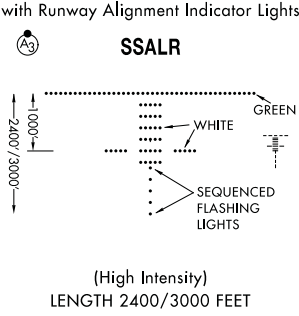

## MEDIUM INTENSITY (MALS and MALSF) OR SIMPLIFIED SHORT (SSALS and SSALF) APPROACH LIGHTING SYSTEMS

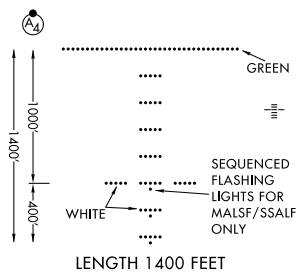

## MEDIUM INTENSITY APPROACH LIGHTING SYSTEM with Runway Alignment Indicator Lights



## OMNIDIRECTIONAL APPROACH LIGHTING SYSTEM

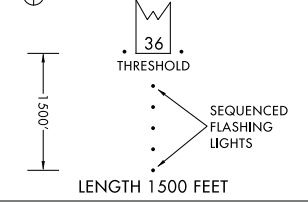

## VISUAL APPROACH SLOPE INDICATOR

**VASI**  
VISUAL APPROACH SLOPE INDICATOR WITH STANDARD THRESHOLD CLEARANCE PROVIDED.  
ALL LIGHTS WHITE — TOO HIGH  
FAR LIGHTS RED — ON GLIDE SLOPE  
NEAR LIGHTS WHITE — ON GLIDE SLOPE  
ALL LIGHTS RED — TOO LOW

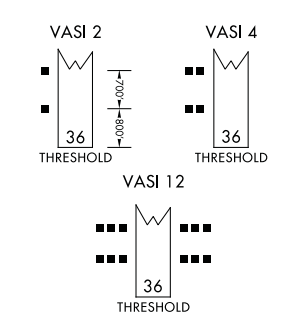

## VISUAL APPROACH SLOPE INDICATOR

**VASI**  
3-BAR, 6 OR 16 BOX, VISUAL APPROACH SLOPE INDICATOR THAT PROVIDES 2 GLIDE ANGLES AND 2 THRESHOLD CROSSING HEIGHTS.

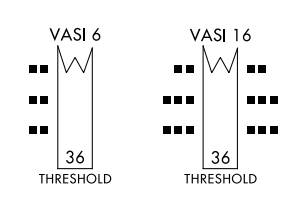

FAA Chart Users' Guide - Terminal Procedures Publication (TPP) - Symbols

21 MAY 2020 to 18 JUN 2020

21 MAY 2020 to 18 JUN 2020

LEGEND 15344



# APPROACH LIGHTING SYSTEM (Continued)

LEGEND 18256

## INSTRUMENT APPROACH PROCEDURES (CHARTS) APPROACH LIGHTING SYSTEM - UNITED STATES

Approach lighting and visual glide slope systems are indicated on the airport sketch by an identifier, (A<sub>2</sub>), (V) etc.

A dot "•" portrayed with approach lighting letter identifier indicates sequenced flashing lights (F) installed with the approach lighting system e.g., (A<sub>1</sub>). Negative symbology, e.g., (A<sub>1</sub>), (V) indicates Pilot Controlled Lighting (PCL).

**(P) PRECISION APPROACH PATH INDICATOR**  
**PAPI**

Legend: □ White ■ Red

**(V<sub>2</sub>) PULSATING VISUAL APPROACH SLOPE INDICATOR**  
**PVASI**

CAUTION: When viewing the pulsating visual approach slope indicators in the pulsating white or pulsating red sectors, it is possible to mistake this lighting aid for another aircraft or a ground vehicle. Pilots should exercise caution when using this type of system.

**(V<sub>1</sub>) "T"-VISUAL APPROACH SLOPE INDICATOR**  
**"T"-VASI**

"T" ON BOTH SIDES OF RWY ALL LIGHTS VARIABLE WHITE. CORRECT APPROACH SLOPE- ONLY CROSS BAR VISIBLE. UPRIGHT "T"- FLY UP. INVERTED "T"- FLY DOWN. RED "T"- GROSS UNDERSHOOT.

**(V<sub>4</sub>) TRI-COLOR VISUAL APPROACH SLOPE INDICATOR**  
**TRCV**

CAUTION: When the aircraft descends from green to red, the pilot may see a dark amber color during the transition from green to red.

21 MAY 2020 to 18 JUN 2020

21 MAY 2020 to 18 JUN 2020

**(V<sub>5</sub>) ALIGNMENT OF ELEMENTS SYSTEMS**  
**APAP**

Painted panels which may be lighted at night. To use the system the pilot positions the aircraft so the elements are in alignment.

**(V<sub>5</sub>) ALIGNMENT OF ELEMENTS SYSTEMS**  
**APAP**

Painted panels which may be lighted at night. To use the system the pilot positions the aircraft so the elements are in alignment.

LEGEND 18256

FAA Chart Users' Guide - Terminal Procedures Publication (TPP) - Symbols

# AIRPORT DIAGRAM/AIRPORT SKETCH

19339

## LEGEND

### INSTRUMENT APPROACH PROCEDURES (CHARTS)

#### AIRPORT DIAGRAM/AIRPORT SKETCH

**Runways**

Hard Surface	Other Than Hard Surface	Stopways, Taxiways, Parking Areas	Metal Surface
Closed Runway	Closed Surface	Under Construction	Water Runway

ARRESTING GEAR: Specific arresting gear systems; e.g., BAK12, MA-1A etc., shown on airport diagrams, not applicable to Civil Pilots. Military Pilots refer to appropriate DOD publications.

uni-directional bi-directional Jet Barrier

ARRESTING SYSTEM (EMAS)

**REFERENCE FEATURES**

Displaced Threshold.....	
Hot Spot.....	
Runway Holding Position Markings.....	
Buildings.....	
24-Hour Self-Serve Fuel ##.....	
Tanks.....	
Obstructions.....	
Airport Beacon #.....	
Runway Radar Reflectors.....	
Control Tower #.....	TWR

# When Control Tower and Rotating Beacon are co-located, Beacon symbol will be used and further identified as TWR.

## A fuel symbol is shown to indicate 24-hour self-serve fuel available, see appropriate Chart Supplement for information.

**NOTE:**  
All new and revised airport diagrams are shown referenced to the World Geodetic System (WGS) (noted on appropriate diagram), and may not be compatible with local coordinates published in FLIP. (Foreign Only)

Runway Weight Bearing Capacity/or PCN Pavement Classification Number is shown as a codified expression. Refer to the appropriate Supplement/Directory for applicable codes e.g., RWY 14-32 PCN 80 F/D/X/U S-75, D-185, 2S-175, 2D-325

Helicopter Alighting Areas

Negative Symbols used to identify Copter Procedures landing point.....

**NOTE:**  
Landmark features depicted on Copter Approach insets and sketches are provided for visual reference only.

Runway TDZ elevation.....TDZE 123

Runway Slope.....0.3% DOWN

Runway Slope.....0.8% UP   
(shown when runway slope is greater than or equal to 0.3%)

**NOTE:**  
Runway Slope measured to midpoint on runways 8000 feet or longer.

U.S. Navy Optical Landing System (OLS) "OLS" location is shown because of its height of approximately 7 feet and proximity to edge of runway may create an obstruction for some types of aircraft.

Approach light symbols are shown in the Flight Information Handbook.

Airport diagram scales are variable.

True/magnetic North orientation may vary from diagram to diagram

Coordinate values are shown in 1 or 1/2 minute increments. They are further broken down into 6 second ticks, within each 1 minute increments.

Positional accuracy within ±600 feet unless otherwise noted on the chart.

Runway length depicted is the physical length of the runway (end-to-end, including displaced thresholds if any) but excluding areas designated as stopways.

A **D** symbol is shown to indicate runway declared distance information available, see appropriate Chart Supplement for distance information.

**SCOPE**

Airport diagrams are specifically designed to assist in the movement of ground traffic at locations with complex runway/taxiway configurations. Airport diagrams are not intended to be used for approach and landing or departure operations. For revisions to Airport Diagrams: Consult FAA Order 7910.4.

21 MAY 2020 to 18 JUN 2020

21 MAY 2020 to 18 JUN 2020

FAA Chart Users' Guide - Terminal Procedures Publication (TPP) - Symbols

## LEGEND

# PLANVIEW SYMBOLS

LEGEND 20086

## INSTRUMENT APPROACH PROCEDURES (CHARTS)

### PLANVIEW SYMBOLS

#### TERMINAL ROUTES

Procedure Track  
 Missed Approach  
 Visual Flight Path

Procedure Turn  
 (Type degree and point of turn optional)

3100 NoPT 5.6 NM to GS Intcpt  
 045°  
 Minimum Route (14.2 to LOM)  
 Altitude 2000  
 Feeder Route 155°  
 Mileage (15.1)

#### HOLDING PATTERNS

Missed Approach

Hold-in-lieu of Procedure Turn

Arrival

HOLD 8000  
 090°  
 1 min  
 270°  
 090° (IAS)  
 270°  
 4 NM

Holding pattern with max. restricted airspeed:  
 (175K) applies to all altitudes.  
 (210K) applies to altitudes above 6000' to and including 14000'.  
 Arrival Holding Pattern altitude restrictions will be indicated when they deviate from the adjacent leg.  
 Timing or distance limits for Hold-in-lieu of Procedure Turn Holding Patterns will be shown.  
 DME fixes may be shown.

#### FIXES/ATC REPORTING REQUIREMENTS

Reporting Point  
 ▲ Name (Compulsory)  
 △ Name (Non-Compulsory)

✦ WAYPOINT (Compulsory)   ✧ WAYPOINT (Non-Compulsory)

⬠ FLYOVER POINT   Ⓞ MAP WP (Flyover)

Computer Navigation Fix (CNF) - No ATC Function  
 x (NAME) ("x" omitted when it conflicts with runway pattern)

DME Distance From Facility  
 AUSTN INT  
 ARC/DME/RNAV Fix

R-198 Radial line and value  
 LR-198 Lead Radial  
 LB-198 Lead Bearing

#### ALTITUDES

5500 Mandatory Altitude   3000 Recommended Altitude  
2500 Minimum Altitude   5000 Mandatory Block  
4300 Maximum Altitude   3000 Altitude

#### INDICATED AIRSPEED

175K   120K   250K   180K  
 Mandatory   Minimum   Maximum   Recommended  
 Airspeed   Airspeed   Airspeed   Airspeed

#### RADIO AIDS TO NAVIGATION

110.1 Underline indicates No Voice transmitted on this frequency

Compulsory:  
 ● VOR   ● VORTAC   ■ DME  
 ● VOR/DME   ● TACAN   ● NDB   ● NDB/DME

Non-Compulsory:  
 ○ VOR   ○ VORTAC   □ DME  
 □ VOR/DME   □ TACAN   ○ NDB   □ NDB/DME

LOM/LMM (Compass locator at Outer Marker/Middle Marker)  
 Marker Beacon  
 Marker beacons that are not specifically part of the procedure.

Localizer (LOC/LDA) Course  
 Right side shading- Front course; Left side shading- Back Course  
 SDF Course

☑ LOC/DME  
 ○ LOC/LDA/SDF Transmitter  
 (shown when installation is offset from its normal position off the end of the runway.)

Primary Navaid with Coordinate Values  
 LIMA  
 114.5 LMM  
 Chan 92  
 512°00.80'  
 W77°07.00'

Secondary Navaid  
 LMM  
 LIMA  
 248 NT

SCOTT  
 Chan 59  
 SKE  
 (112.2)  
 VHF Paired Frequency

21 MAY 2020 to 18 JUN 2020

21 MAY 2020 to 18 JUN 2020

FAA Chart Users' Guide - Terminal Procedures Publication (TPP) - Symbols

LEGEND 20086

# PLANVIEW SYMBOLS (Continued)

LEGEND 19171 INSTRUMENT APPROACH PROCEDURES (CHARTS)

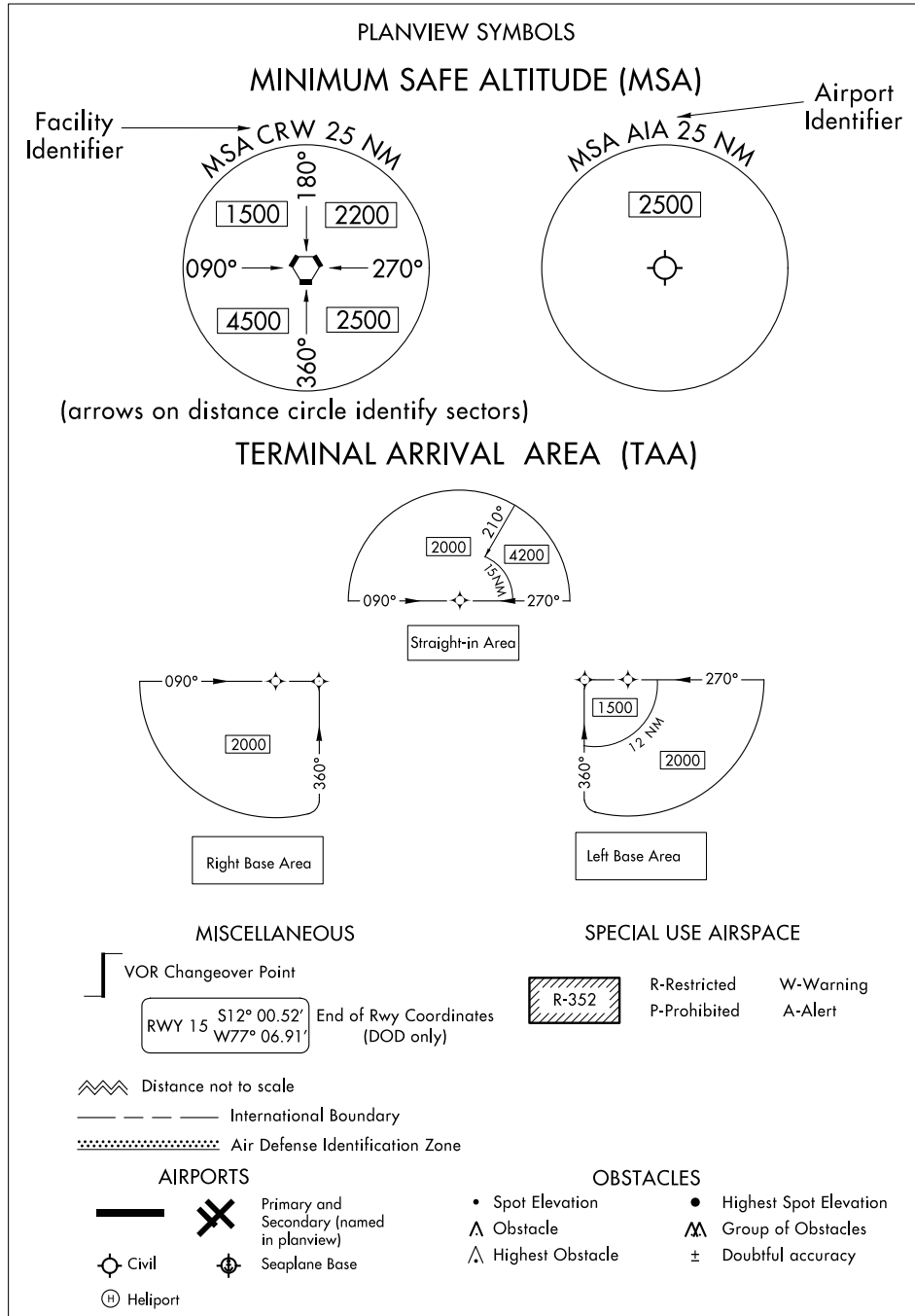

21 MAY 2020 to 18 JUN 2020

21 MAY 2020 to 18 JUN 2020

LEGEND 19171

# PROFILE VIEW

## LEGEND 18200 INSTRUMENT APPROACH PROCEDURES (CHARTS)

### PROFILE VIEW

- Three different methods are used to depict either electronic or vertical guidance: "GS", "GP", or "VDA".
- "GS" indicates that an Instrument Landing System (ILS) electronic glide slope (a ground antenna) provides vertical guidance. The profile section of ILS procedures depict a GS angle and TCH in the following format:  $GS\ 3.00^\circ$  / TCH 55
  - "GP" on GLS and RNAV procedures indicates that either electronic vertical guidance (via Wide Area Augmentation System - WAAS or Ground Based Augmentation System - GBAS) or barometric vertical guidance is provided. GLS and RNAV procedures with a published decision altitude (DA/H) depict a GP angle and TCH in the following format:  $GP\ 3.00^\circ$  / TCH 50
  - An advisory vertical descent angle (VDA) is provided on non-vertically guided conventional procedures and RNAV procedures with only a minimum descent altitude (MDA) to assist in preventing controlled flight into terrain. On Civil (FAA) procedures, this information is placed above or below the procedure track following the fix it is based on. Absence of a VDA or a note that the VDA is not authorized indicates that the prescribed obstacle clearance surface is not clear and the VDA must not be used below MDA. VDA is depicted in the following format:  $\leq 3.00^\circ$ . On Copter procedures this is depicted in the following format:  $\leq 7.30^\circ$  / HCH 20

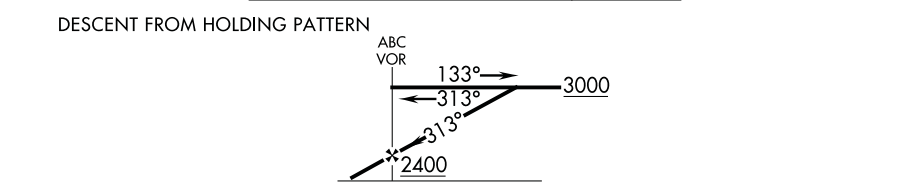
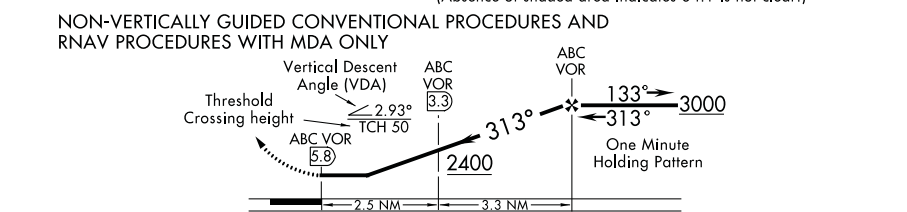
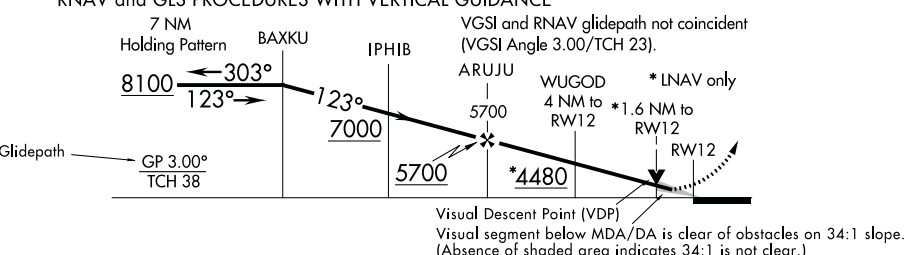
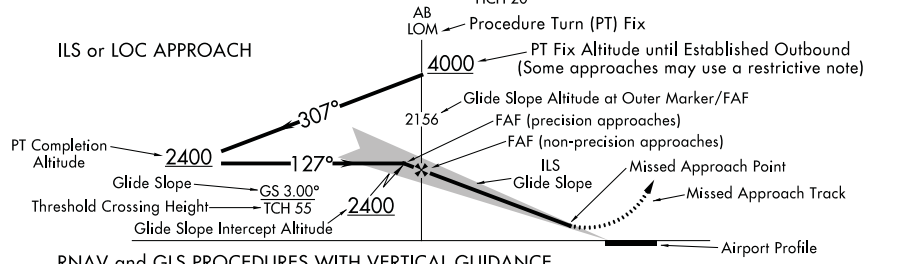

ALTITUDES		PROFILE SYMBOLS	
<u>5500</u> Mandatory Altitude	3000 Recommended Altitude	$\nearrow$ Glide Slope/Glidepath Intercept Altitude and final approach fix for vertically guided approach procedures.	$\dashrightarrow$ Visual Flight Path
<u>2500</u> Minimum Altitude	<u>5000</u> Mandatory Block Altitude	$\nabla$ Visual Descent Point (VDP)	$\vdots$ Note: Facilities and waypoints are depicted as a solid vertical line while fixes and intersections are depicted as a dashed vertical line.
<u>4300</u> Maximum Altitude	<u>3000</u> Altitude		

21 MAY 2020 to 18 JUN 2020

21 MAY 2020 to 18 JUN 2020

FAA Chart Users' Guide - Terminal Procedures Publication (TPP) - Symbols

## LEGEND 18200

# COLD TEMPERATURE AIRPORTS

## COLD TEMPERATURE AIRPORTS

NOTE: A -12°C symbol indicates a cold temperature altitude correction is required at this airport when reported temperature is at or below the published temperature. See the following Cold Temperature Error Table to make manual corrections. Advise ATC with altitude correction. Advising ATC with altitude corrections is not required in the final segment. See Aeronautical Information Manual (AIM), Chapter 7, for guidance and additional information. For a complete list, see the "Cold Temperature Airports" link under the Additional Resources heading at the bottom of the following page: [http://www.faa.gov/air\\_traffic/flight\\_info/aeronav/digital\\_products/dtpp/search/](http://www.faa.gov/air_traffic/flight_info/aeronav/digital_products/dtpp/search/)

## COLD TEMPERATURE ERROR TABLE

		HEIGHT ABOVE AIRPORT IN FEET													
		200	300	400	500	600	700	800	900	1000	1500	2000	3000	4000	5000
REPORTED TEMP °C	+10	10	10	10	10	20	20	20	20	20	30	40	60	80	90
	0	20	20	30	30	40	40	50	50	60	90	120	170	230	280
	-10	20	30	40	50	60	70	80	90	100	150	200	290	390	490
	-20	30	50	60	70	90	100	120	130	140	210	280	420	570	710
	-30	40	60	80	100	120	140	150	170	190	280	380	570	760	950
	-40	50	80	100	120	150	170	190	220	240	360	480	720	970	1210
	-50	60	90	120	150	180	210	240	270	300	450	590	890	1190	1500

# REFERENCES

There are several references available from the FAA to aid pilots and other interest parties to learn more about FAA Charts and other aspects of aviation.

Publication		FAA Publication ID
	<p>Aeronautical Information Manual (AIM)</p> <p>URL: <a href="http://www.faa.gov/air_traffic/publications/">http://www.faa.gov/air_traffic/publications/</a></p>	
	<p>Airplane Flying Handbook</p> <p>URL: <a href="https://www.faa.gov/regulations_policies/handbooks_manuals/aviation/airplane_handbook/">https://www.faa.gov/regulations_policies/handbooks_manuals/aviation/airplane_handbook/</a></p>	FAA-H-8083-3A
	<p>Helicopter Flying Handbook</p> <p>URL: <a href="http://www.faa.gov/regulations_policies/handbooks_manuals/aviation/helicopter_flying_handbook/">http://www.faa.gov/regulations_policies/handbooks_manuals/aviation/helicopter_flying_handbook/</a></p>	FAA-H-8083-21A
	<p>Instrument Procedures Handbook</p> <p>URL: <a href="http://www.faa.gov/regulations_policies/handbooks_manuals/aviation/instrument_procedures_handbook/">http://www.faa.gov/regulations_policies/handbooks_manuals/aviation/instrument_procedures_handbook/</a></p>	FAA-H-8083-16B
	<p>Instrument Flying Handbook</p> <p>URL: <a href="http://www.faa.gov/regulations_policies/handbooks_manuals/aviation/media/FAA-H-8083-15B.pdf">http://www.faa.gov/regulations_policies/handbooks_manuals/aviation/media/FAA-H-8083-15B.pdf</a></p>	FAA-H-8083-15B
	<p>Pilot's Handbook of Aeronautical Knowledge</p> <p>URL: <a href="https://www.faa.gov/regulations_policies/handbooks_manuals/aviation/phak/">https://www.faa.gov/regulations_policies/handbooks_manuals/aviation/phak/</a></p>	FAA-H-8083-25B
	<p>Remote Pilot - Small Unmanned Aircraft Systems Study Guide</p> <p>URL: <a href="http://www.faa.gov/regulations_policies/handbooks_manuals/aviation/media/remote_pilot_study_guide.pdf">http://www.faa.gov/regulations_policies/handbooks_manuals/aviation/media/remote_pilot_study_guide.pdf</a></p>	FAA-G-8082-22





# ABBREVIATIONS

## A

AAF - Army Air Field  
AAS - Airport Advisory Service  
AAUP - Attention All Users Page  
AC - Advisory Circular  
ADF - Automatic Direction Finder  
ADIZ - Air Defense Identification Zone  
ADS - Automatic Dependent Surveillance  
ADS-B - Automatic Dependent Surveillance-Broadcast  
Advrsy - Advisory  
AFB - Air Force Base  
AFIS - Automatic Flight Information Service  
AFS - Air Force Station  
AFSS - Automated Flight Service Station  
AGL - Above Ground Level  
AIM - Aeronautical Information Manual  
AIRAC - Aeronautical Information Regulation And Control  
AK - Alaska  
AL - Approach and Landing  
ANG - Air National Guard  
APP - Approach  
APP CON - Approach Control  
APP CRS - Approach Course  
Apt - Airport  
APV - Approaches with Vertical Guidance  
ARP - Airport Reference Point  
ARTCC - Air Route Traffic Control Center  
ASDA - Accelerate-Stop Distance Available  
ASDE-X - Airport Surface Detection Equipment-Model X  
ASOS - Automated Surface Observing Station  
ASR - Airport Surveillance Radar  
ATC - Air Traffic Control  
ATIS - Automatic Terminal Information Service  
ATS - Air Traffic Service  
AUNICOM - Automated Aeronautical Advisory Station  
AWOS - Automated Weather Observing Station

## B

Baro-VNAV - Barometric Vertical Navigation  
BS - Broadcast Station

## C

CAC - Caribbean Aeronautical Chart  
CAT - Category  
CFA - Controlled Firing Areas  
CFR - Code of Federal Regulations  
CH - Channel  
CL - Runway Centerline Lights  
CLNC DEL - Clearance Delivery  
CNF - Computer Navigation Fix  
COP - Changeover Point  
CPDLC - Controller Pilot Data Link Communication  
CRS - Course  
CT - Control Tower

CTAF - Common Traffic Advisory Frequency  
CVFP - Charted Visual Flight Procedure  
CZ - Control Zone (Canada)

## D

DA - Decision Altitude  
DA - Density Altitude  
D-ATIS - Digital Automatic Terminal Information Service  
DH - Decision Height  
DME - Distance Measuring Equipment  
DND - Department of National Defense (Canada)  
DoD - Department of Defense  
DOF - Digital Obstacle File  
DP - Departure Procedure  
DT - Daylight Savings Time  
DVA - Diverse Vector Area

## E

E - East  
EFAS - Enroute Flight Advisory Service  
EFB - Electronic Flight Bag  
Elev - Elevation  
EMAS - Engineered Materials Arresting System

## F

FAA - Federal Aviation Administration  
FAF - Final Approach Fix  
FAP - Final Approach Point  
FAR - Federal Aviation Regulation  
FBO - Fixed-Based Operator  
FIR - Flight Information Region  
FL - Flight Level  
FLIP - Flight Information Publication  
FMS - Flight Management System  
FREQ - Frequency  
FRZ - Flight Restricted Zone  
FSDO - Flight Standards District Office  
FSS - Flight Service Station

## G

GBAS - Ground-Based Augmentation System  
GCO - Ground Communications Outlet  
GLS - GBAS Landing System  
GND - Ground  
GND CON - Ground Control  
GNSS - Global Navigation Satellite System  
GP - Glide Path  
GPS - Global Positioning System  
GS - Glide Slope  
GS - Ground Speed

## H

HAA - Height Above Airport  
 HAR - High Altitude Redesign  
 HAT - Height Above Touchdown  
 HCH - Heliport Crossing Height  
 HF - High Frequency  
 HIRL - High Intensity Runway Lights  
 HS - Hot Spot

## I

IAC - Interagency Air Committee  
 IACC - Interagency Air Cartographic Committee  
 IAF - Initial Approach Fix  
 IAP - Instrument Approach Procedure  
 ICAO - International Civil Aviation Authority  
 IDT - Identifier  
 IF - Intermediate Fix  
 IFR - Instrument Flight Rules  
 ILS - Instrument Landing System  
 IMC - Instrument Meteorological Conditions  
 INS - Inertial Navigation System  
 IR - Instrument Route (Military)  
 IRU - Inertial Reference Unit

## J

JO - Joint Order

## K

KIAS - Knots

## L

LAA - Local Airport Advisory  
 LAAS - Local Area Augmentation System  
 LAHSO - Land and Hold Short  
 LDA - Landing Distance Available  
 LDA - Localizer-type Directional Aid  
 Ldg - Landing  
 LF - Low Frequency  
 LIRL - Low Intensity Runway Lights  
 LNAV - Lateral Navigation  
 LOC - Localizer  
 LOM - Locator Outer Marker  
 LPV - Localizer Performance with Vertical Guidance  
 LRRS - Long Range Radar Station  
 LTP - Landing Threshold Point

## M

MAA - Maximum Authorized Altitude  
 MAP - Missed Approach Point  
 MCA - Minimum Crossing Altitude  
 MCAS - Marine Corps Air Station  
 MDA - Minimum Descent Altitude  
 MDH - Minimum Descent Height

MEA - Minimum Enroute Altitude  
 MEF - Maximum Elevation Figure  
 MF - Medium Frequency  
 MIA - Minimum IFR Altitude  
 MIRL - Medium Intensity Runway Lights  
 MOA - Military Operations Areas  
 MOCA - Minimum Obstruction Clearance Altitude  
 MON - Minimum Operational Network  
 MORA - Minimum Off-Route Altitude  
 MRA - Minimum Reception Altitude  
 MSA - Minimum Safe Altitude  
 MSL - Mean Sea Level  
 MTA - Minimum Turning Altitude  
 MTR - Military Training Route  
 MVA - Minimum Vector Altitude

## N

N - North  
 N/A - Not Applicable  
 NA - Not Authorized  
 NAAS - Naval Auxiliary Air Station  
 NAS - Naval Air Station  
 NAS - National Airspace System  
 NAV - Naval Air Facility  
 NAVAID - Navigational Aid (Ground based)  
 NDB - Non-Directional Radiobeacon  
 NextGen - Next Generation Air Transportation System  
 NFDC - National Flight Data Center  
 NFPO - National Flight Procedures Office  
 NM - Nautical Mile  
 NOAA - National Oceanic and Atmospheric Administration  
 NO A/G - No Air-to-Ground Communication  
 NOTAM - Notice to Airman  
 NoPT - No Procedure Turn  
 NPA - Non-Precision Approach  
 NTAP - Notices to Airman Publication  
 NWS - National Weather Service

## O

OAT - Outside Air Temperature  
 OBS - Omni Bearing Selector  
 OCA - Ocean Control Area  
 OCS - Obstacle Clearance Surface  
 ODP - Obstacle Departure Procedure  
 OM - Outer Marker  
 OROCA - Off Route Obstruction Clearance Altitude

## P

PA - Precision Approach  
 PAR - Precision Approach Radar  
 PBN - Performance-Based Navigation  
 PRM - Precision Runway Monitor  
 PT - Procedure Turn  
 PTP - Point-to-Point  
 Pvt - Private

## R

R - Radial  
R - Receive  
R - Restricted Area (Special Use Airspace)  
RCO - Remote Communications Outlet  
RF - Radius-to-Fix  
RNAV - Area Navigation  
RNP - Required Navigation Performance  
RNP AR - Required Navigation Performance Authorization  
Required  
ROC - Required Obstacle Clearance  
RP - Right Pattern  
RVR - Runway Visual Range  
RVSM - Reduced Vertical Separation Minimum  
Rwy - Runway

## S

S - South  
SAAAR - Special Aircraft and Aircrew Authorization  
Required  
SAAR - Special Aircraft and Aircrew Requirements  
SATNAV - Satellite Navigation  
SDF - Simplified Directional Facility  
SER - Start End of Runway  
SFAR - Special Flight Rules Area  
SFC - Surface  
SFRA - Special Flight Rules Area  
SIAPs - Standard Instrument Approach Procedures  
SID - Standard Instrument Departure  
SM - Statute Mile  
SMAR - Special Military Activity Routes  
SMGCS - Surface Movement Guidance and Control  
System  
SOIA - Simultaneous Offset Instrument Approaches  
SSV - Standard Service Volume  
STAR - Standard Terminal Arrival Procedure  
SUA - Special Use Airspace  
SVFR - Special Visual Flight Rules

## T

T - Transmit  
TA - Travel Advisory  
TAA - Terminal Arrival Area  
TAC - Terminal Area Chart  
TACAN - Tactical Air Navigation  
TAS - True Air Speed  
TCA - Terminal Control Areas (Canada)  
TCH - Threshold Crossing Height  
TDZ - Touchdown Zone  
TDZE - Touchdown Zone Elevation  
TDZL - Touchdown Zone Lights  
TDZ/CL - Touchdown Zone/Centerline Lights  
TERPS - U.S. Standard for Terminal Instrument Procedures  
TFR - Temporary Flight Restriction  
TIBS - Telephone Information Briefing Service  
TIS-B - Traffic Information Service - Broadcast

TOC - Top of Climb  
TOD - Top of Descent  
TODA - Takeoff Distance Available  
TOGA - Takeoff/Go Around  
TORA - Takeoff Runway Available  
TPP - Terminal Procedures Publication  
TRSA - Terminal Radar Service Area  
TWR - Tower

## U

UC - Under Construction  
UHF - Ultra High Frequency  
UIR - Upper Information Region  
UNICOM - Universal Communications  
U.S. - United States  
USA - United States Army  
USAF - United States Air Force  
USCG - United State Coast Guard  
UTA - Upper Control Area

## V

VCOA - Visual Climb Over Airport / Airfield  
VDA - Vertical Descent Angle  
VDP - Visual Decent Point  
VFR - Visual Flight Rules  
VGSI - Visual Glide Slope Indicator  
VHF - Very High Frequency  
VMC - Visual Meteorological Conditions  
VNAV - Vertical Navigation  
VOR - VHF Omnidirectional Radio Range  
VORTAC - VHF Omnidirectional Radio Range/Tactical Air  
Navigation  
VPA - Vertical Path Angle  
VR - Visual Route (Military)

## W

W - Warning Area (Special Use Airspace)  
W - West  
WAAS - Wide-Area Augmentation System  
WAC - World Aeronautical Chart  
WP - Waypoint  
WX CAM - Weather Camera (Alaska)